



3. poglavlje

## Radne ploče i ploče stola

## Sadržaj

|      |  |
|------|--|
| 3.4  | Kuhinjske zidne obloge                             |
| 3.6  | Kompakt ploče                                      |
| 3.11 | PerfectSense Topmat MDF radne ploče debljine 16 mm |
| 3.13 | Radne ploče i ploče stola                          |
| 3.80 | Ugradbena granitna ploča                           |
| 3.81 | Kutne letve, setovi kutnika                        |
| 3.83 | Perfect Line kutna letva                           |
| 3.84 | Spojni okov radnih ploča                           |
| 3.85 | Okovi radnih ploča                                 |
| 3.86 | Konzole  |

### Kazalo

Oznaka artikla: **Naziv artikla**

broj artikla: 10012503002

Na našoj web stranici pod nazivom: Obavijesti kupcima, možete pronaći dokumente vezane uz proizvode:  
[www.foresteu.com/vasarloi-tajekoztatok](http://www.foresteu.com/vasarloi-tajekoztatok)



### Napomena!

Za eventualno nastalu štetu na proizvodu prilikom nestručne manipulacije i ugradnje ne snosimo odgovornost. Predmeti topliji od 100 °C mogu oštetiti površinu radne ploče! Prilikom uporabe istih dekora radnih i laminatnih ploča, te ploča za stolove treba uzeti u obzir da su moguća manja odstupanja u nijansi artikala! Proizvođač vrši stalno usavršavanje proizvoda uslijed čega može doći do neznatnih promjena proizvoda u odnosu na one koji se nalaze u katalogu! Kod određenih dekora radnih ploča, na maloj se površini ne može vidjeti cjeloviti uzorak. Molimo Vas da u takvim slučajevima zatražite uzorak većih dimenzija. Boje u katalogu uslijed reprodukcijskog postupka i tiskarske tehnologije mogu pokazati manje odstupanje od stvarnih boja. Za eventualne pogreške nastale pri tiskanju ne snosimo nikakvu odgovornost!

U katalogu su prikazane dvije slike radnih ploča i ploča stola. Prva manja je realan isječak 1:1, a druga je smanjena slika odrezanog komada 600 x 1500 mm.

Kod oblaganja sa laminatnim pločama potrebno je naljepiti kontra ploču na zadnju stranu podloge.

Dimenzija: 3050 x1300 mm, broj artikla: 10011309996

### Za odabir određenih artikala mogu Vam pomoći sljedeće oznake:

- |   |   |
|---|---|
| <b>Realna dimenzija</b> • Prikaz u realnoj veličini. Godovi se mogu vidjeti u realnoj veličini.                     | <b>Iveral</b><br>Uz navedeni artikal dostupan je iveral u istom dekoru.   |
| <b>Smanjena dimenzija</b> • Prikaz u smanjenoj veličini. Veličina uzorka 600 x 1500 mm.                             | <b>Ekkluziv</b><br>Visoka kvaliteta i dizajn.   |
| <b>Debljina</b> • Označava debljinu radnih ploča, ploča za stolove i debljinu panela u mm.                          | <b>Najpovoljnija cijena</b><br>Najpovoljniji artikal u kategoriji.  |
| <b>Radius</b> • Označava radius ili kosinu ruba radnih ploča i ploča za stolove u mm                                | <b>Istaknuti artikal</b><br>Osim radnih ploča dubine 600 mm, sa skladišnih zalih su dostupne i radne ploče dubine 1200 mm (zaobljene sa jedne strane), te ploče stola od 900 ili 920 mm (zaobljene sa obje strane). |
| <b>Površina visokog sjaja</b> • Površine visokog sjaja radnih ploča i ploča za stolove su posebno naznačene.        | <b>Odličan odnos cijene i kvalitete</b><br>Povoljni artikli dobre kvalitete.  |
| <b>Feel Wood površina</b><br>Više informacija na str. 3.28  |   |
| <b>Kuhinjske zidne obloge</b> • Za prostor između gornjih i donjih kuhinjskih elemenata. Vidi više na str.: 3.4-3.5 |   |

# Kvalitetno konfekcioniranje postforming proizvoda

Gotovi proizvodi za interijere



- Najmodernija tehnologija i stručno znanje
- Kvalitetni materijali
- Spajanje materijala i unaprijeđeno porubljivanje s povećanom otpornošću na vlagu, paru i toplinu
- Ne vodite brigu o otpacima
- Minimalan otpad materijala, suglasje s ekološkim zahtjevima



- konfekcioniranje po mjeri
- ravnocrtna i krivocrtna obrada
- bušenje rupa za okove
- debljinsko spajanje ploča
- ostale obrade (izrezivanje otvora, glodanje)
- porubljivanje



Na našoj Web stranici možete pronaći kratke filmove o različitim mogućnostima ugradnje radnih ploča:  
[www.foresteu.com/filmek](http://www.foresteu.com/filmek)



## Kuhinjske zidne obloge



- Kuhinjske obloge su dostupne u dimenziji 640 x 4100 x 8 mm. Na nosivom materijalu od iverice, sa obje se strane nalaze laminatni paneli u dvije različite boje, te se jedna zidna obloga može ugrađivati sa ta dva dekora radnih ploča.
- Ugradnjom kuhinjskih zidnih obloga brzo i jednostavno možemo obložiti zid između gornjih i donjih elemenata sa površinom, po izgledu i svojstvima, identičnoj sa površinom radne ploče. Kuhinjske zidne obloge su pogodne i za oblaganje drugih unutarnjih površina i svoju primjenu mogu imati u najrazličitijim situacijama.
- Trenutno u ponudi imamo 43 dekora kuhinjskih zidnih obloga koje odgovaraju Eggerovim dekorima. Osim toga, u ponudi imamo i 5 dekora koji se distribuiraju samo kao kuhinjske zidne obloge. Artikle koji se dekorno podudaraju sa dekorom radne ploče označili smo piktogramom uz koji navodimo i broj artikla.
- Kuhinjske zidne obloge se mogu naručiti u komadima ili krojene na mjeru po želji kupca.

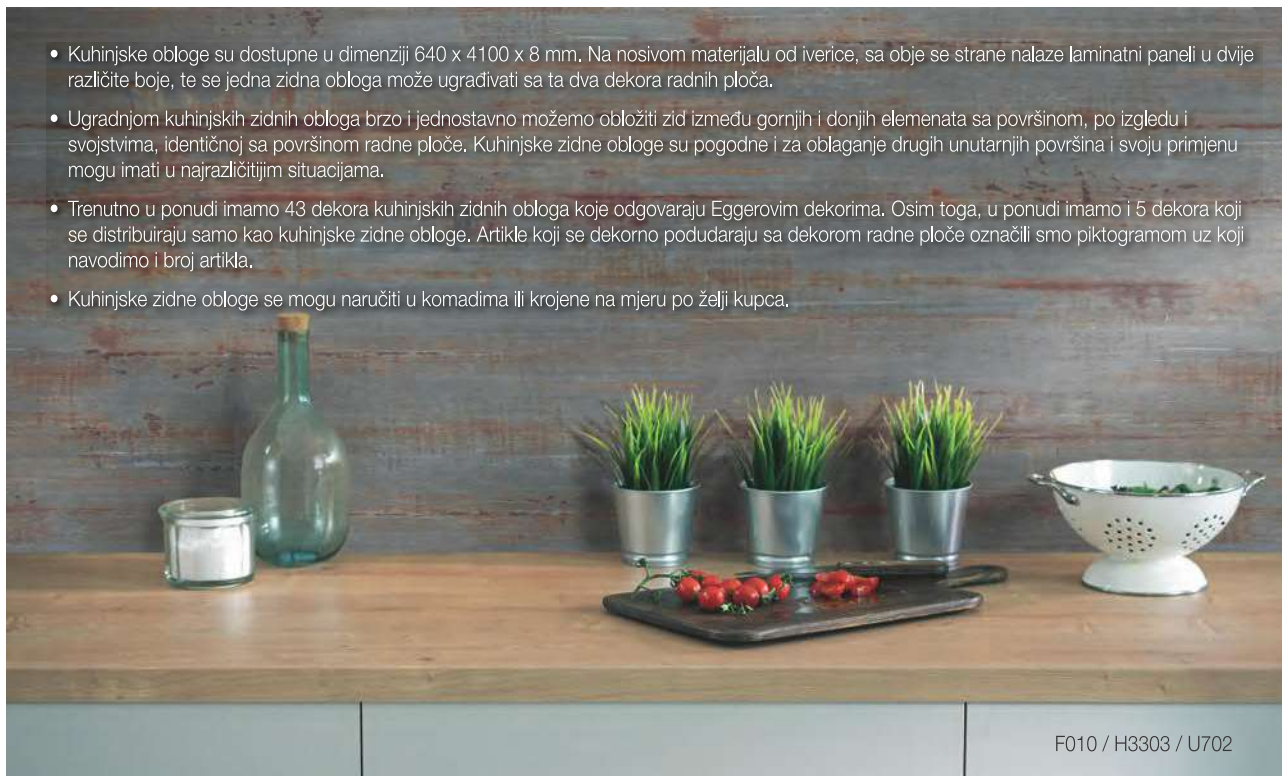

F010 / H3303 / U702

## Ornamentic Wood H192 ST10

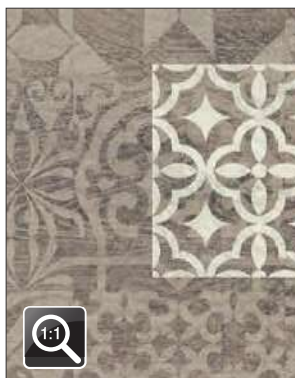

| Kuhinjska zidna obloga (mm) |             |
|-----------------------------|-------------|
| 8 x 640 x 4100              | 10012590010 |

## Terra Brown Quarry Stone F007 ST10

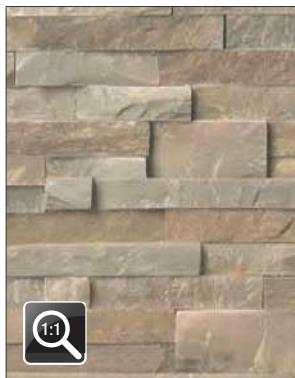

| Kuhinjska zidna obloga (mm) |             |
|-----------------------------|-------------|
| 8 x 640 x 4100              | 10012590120 |



## Kuhinjske zidne obloge



## Slate Grey Quarry Stone F008 ST10



|                             |             |
|-----------------------------|-------------|
| Kuhinjska zidna obloga (mm) |             |
| 8 x 640 x 4100              | 10012590120 |

## Mosaic Stone F009 ST9



|                             |             |
|-----------------------------|-------------|
| Kuhinjska zidna obloga (mm) |             |
| 8 x 640 x 4100              | 10012590130 |

## Used Metal Plate F010 ST9



|                             |             |
|-----------------------------|-------------|
| Kuhinjska zidna obloga (mm) |             |
| 8 x 640 x 4100              | 10012590130 |

## Kompakt ploče



- Kompakt ploče sa obje strane imaju dekorativnu površinu. Karakterizira ih velika otpornost na toplinu, vlagu i fizička oštećenja. Ovaj materijal cijelim presjekom odlikuje kompozitna baza.
- Lako se obrađuje tradicionalnim alatima i ne zahtijeva porubljivanje na mjestima prereza.
- Kompakt ploče predstavljaju idealni materijal za izradu kuhinjskih radnih ploča i kupaonskih pultova, te imaju široku primjenu u uređenju interijera.
- U prvom redu se preporučuju za prostore u kojima je imperativ higijena zbog lakog čišćenja, te dobre otpornosti na sredstva za čišćenje.
- Proizvod je isključivo namijenjen za unutarnje prostore!
- Zatražite ponudu od naših djelatnika u slučaju da želite neku posebnu vrstu obrade ploče. (Obrada rubova, izrezi i sl.)

F222 / U702



Spojni okov se  
nalazi na str.:  
**3.85**

## Solid Alpine White W1101 ST76

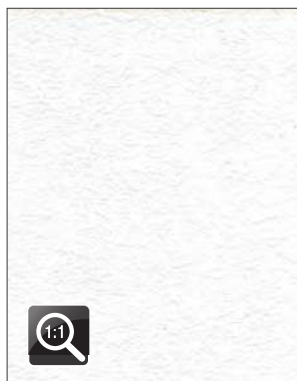

Boja jezgre: bijela



| Radna ploča (mm)    |             |
|---------------------|-------------|
| 12/1x1 x 650 x 4100 | 10012550200 |

| Iveral (mm) ST9  |             |
|------------------|-------------|
| 18 x 2070 x 2800 | 20011100180 |

| Laminat (mm)       |             |
|--------------------|-------------|
| Ploča: 2800 x 1310 | 10011333200 |



## Kompakt ploče



## Solid Light Grey U7081 ST76



| Radna ploča (mm)    |             |
|---------------------|-------------|
| 12/1x1 x 650 x 4100 | 10012550210 |
| Iveral (mm) ST9     |             |
| 18 x 2070 x 2800    | 20010708181 |

| Kuhinjska zidna obloga (mm) ST9 |             |
|---------------------------------|-------------|
| 8 x 640 x 4100                  | 10012590110 |

| Laminat (mm)       |             |
|--------------------|-------------|
| Ploča: 2800 x 1310 | 10011333210 |

## Black U999 ST76

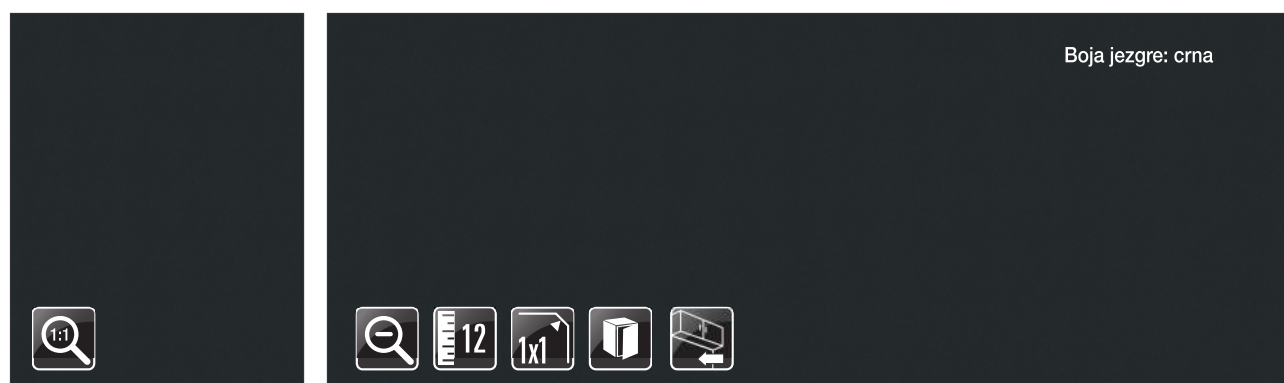

| Radna ploča (mm)     |             |
|----------------------|-------------|
| 12/1x1 x 650 x 4100  | 10012550220 |
| Iveral (mm)          |             |
| 2800 x 2070 x18 ST2  | 20010999180 |
| 2800 x 2070 x18 ST19 | 20010999184 |

| Kuhinjska zidna obloga (mm) ST89 |             |
|----------------------------------|-------------|
| 8 x 640 x 4100                   | 10012590000 |

| Laminat (mm)       |             |
|--------------------|-------------|
| Ploča: 2800 x 1310 | 10011333220 |

## Terra Tessina Ceramic F222 ST76



| Radna ploča (mm)    |             |
|---------------------|-------------|
| 12/1x1 x 650 x 4100 | 10012550230 |

| Kuhinjska zidna obloga (mm) |             |
|-----------------------------|-------------|
| 8 x 640 x 4100              | 10012590240 |

| Laminat (mm)       |             |
|--------------------|-------------|
| Ploča: 2800 x 1310 | 10011333230 |

## Kompakt ploče • SlimLine



## Snow White 8685 SU

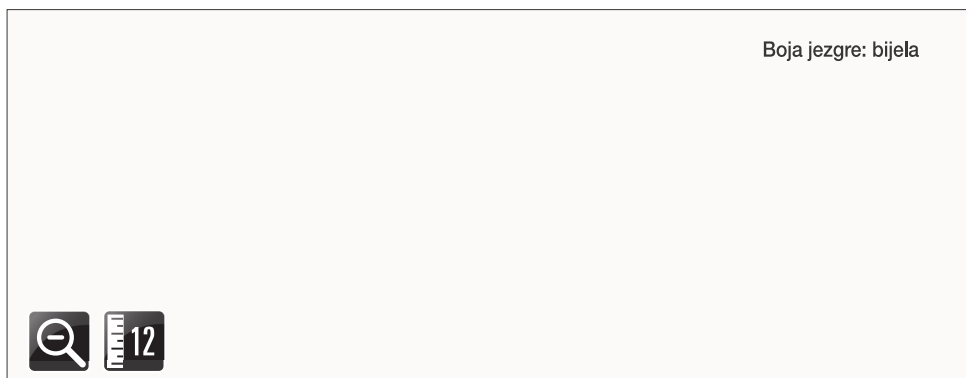
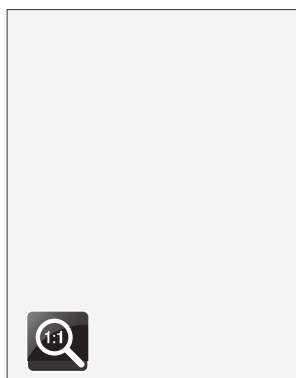

Boja jezgre: bijela



Radna ploča (mm)

12 x 650 x 4100

10012557530

## Black Matt 0190 AF

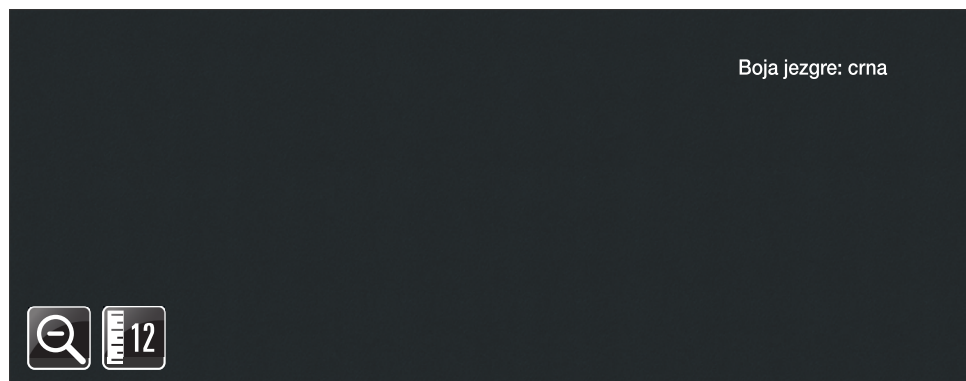
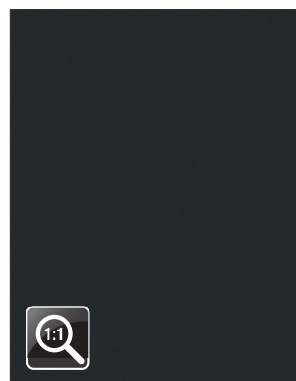

Boja jezgre: crna



Radna ploča (mm)

12 x 650 x 4100

10012557550



## Kompakt ploče • SlimLine



## Black Slate 190 SL

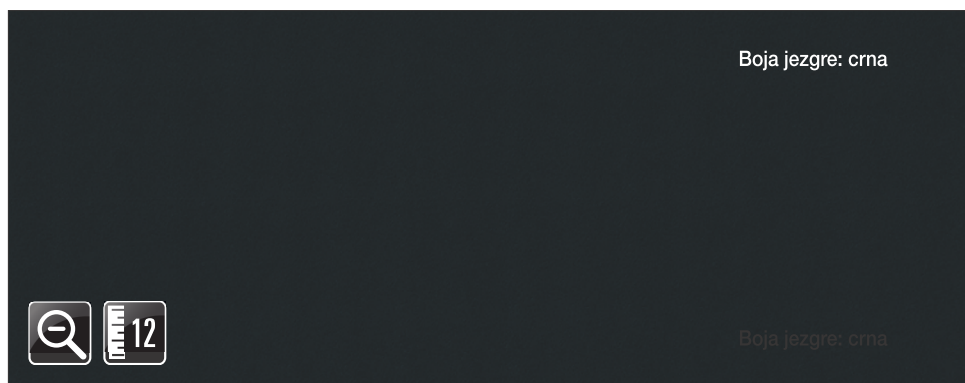
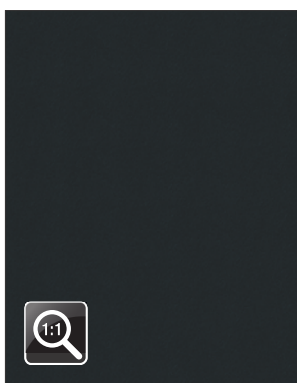

| Radna ploča (mm) |             |
|------------------|-------------|
| 12 x 650 x 4100  | 10012557540 |

## Venato K023 SU

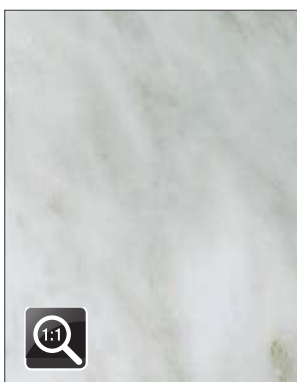

| Radna ploča (mm) |             |
|------------------|-------------|
| 12 x 650 x 4100  | 10012557500 |

## Cream Navona K367 PH



| Radna ploča (mm) |             |
|------------------|-------------|
| 12 x 650 x 4100  | 10012557570 |

## Kompakt ploče • SlimLine



## Portland K028 SU



Boja jezgre: siva



| Radna ploča (mm) |             |
|------------------|-------------|
| 12 x 650 x 4100  | 10012557510 |

## Grey Atlantic Marble K368 PH



Boja jezgre: siva



| Radna ploča (mm) |             |
|------------------|-------------|
| 12 x 650 x 4100  | 10012557560 |

## Peltro K108 SU

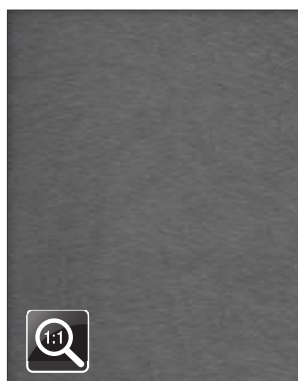

Boja jezgre: crna



| Radna ploča (mm) |             |
|------------------|-------------|
| 12 x 650 x 4100  | 10012557520 |



## PerfectSense Topmat Mdf radne ploče debljine 16 mm



Spojni okov radnih ploča  
se nalazi na str.:

**3.85**

F812

- Egger-ove Topmat PerfectSense radne ploče debljine 16mm imaju jezgru od tvrdog Mdf-a koja na sebi ima specijalnu foliju. Ploče su ravnocrtno porubljene s pojačanom otpornošću na vlagu. Glatka supermat folija prati najnovije trendove u izradi namještaja. Na njoj ne ostaju otisci prstiju, a na dodir je baršunasto topla.
- Elektrostatskom obradom osigurana je značajnija otpornost površine u odnosu na površinu klasičnih materijala.

## Alpine White W1100 PT

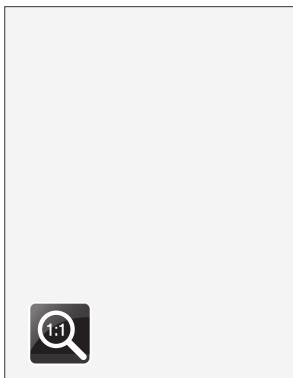

S ravnocrtno porubljenim rubom



| Radna ploča (mm)     |             |
|----------------------|-------------|
| 16/R1,5 x 600 x 4100 | 10012550000 |
| Iveral (mm) ST9      |             |
| 18 x 2070 x 2800     | 20011100180 |

| Kutna letva / setovi kutnika |             |
|------------------------------|-------------|
| Trokutastog presjeka         | 10015802390 |
| tip 56                       | 10015710210 |

| Laminat (mm)               |             |
|----------------------------|-------------|
| Ploča: 2800 x 1310         | 10011333000 |
| Rubna traka / narudžba: tm |             |
| Kod                        | 38811       |

## Black U999 PT

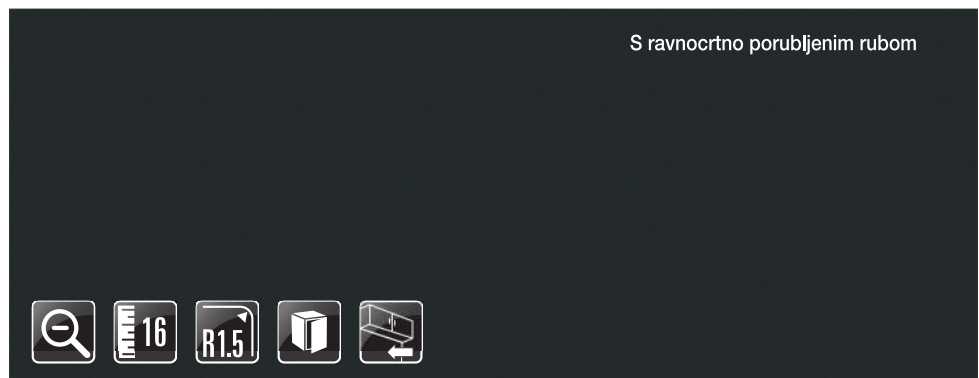
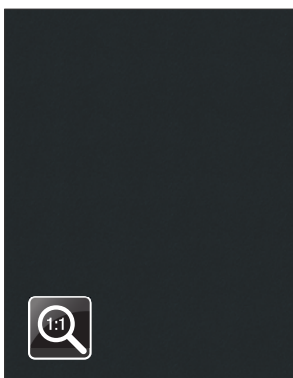

S ravnocrtno porubljenim rubom



| Radna ploča (mm)     |             |
|----------------------|-------------|
| 16/R1,5 x 600 x 4100 | 10012550010 |
| Iveral (mm)          |             |
| 2800 x 2070 x18 ST2  | 20010999180 |
| 2800 x 2070 x18 ST19 | 20010999184 |

| Kuhinjska zidna obloga (mm) ST89 |             |
|----------------------------------|-------------|
| 8 x 640 x 4100                   | 10012590000 |
| Kutna letva / setovi kutnika     |             |
| Trokutastog presjeka             | 10015802395 |
| tip 56                           | 10015710260 |

| Laminat (mm)               |             |
|----------------------------|-------------|
| Ploča: 2800 x 1310         | 10011333010 |
| Rubna traka / narudžba: tm |             |
| Kod                        | 38870       |

## PerfectSense Topmat Mdf radne ploče debljine 16 mm



## Dark Steel F627 PT

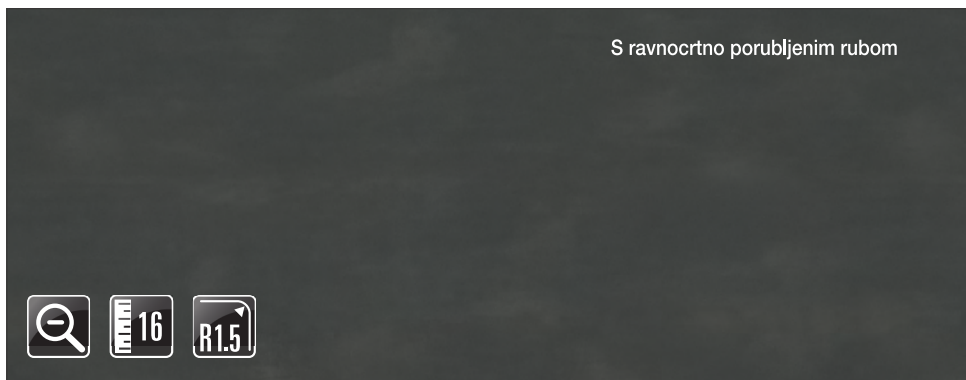
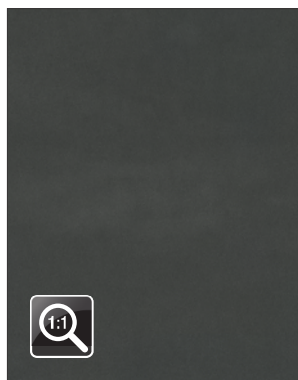

| Radna ploča (mm)     |             |
|----------------------|-------------|
| 16/R1,5 x 600 x 4100 | 10012550030 |

| Kutna letva / setovi kutnika |             |
|------------------------------|-------------|
| Trokutastog presjeka tip 56  | 10015802400 |
|                              | 10015710230 |

| Laminat (mm)               |             |
|----------------------------|-------------|
| Ploča: 2800 x 1310         | 10011333030 |
| Rubna traka / narudžba: tm |             |
| Kod                        | 38875       |

## White Levanto Marble F812 PT

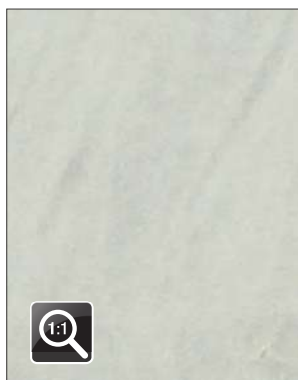

| Radna ploča (mm)     |             |
|----------------------|-------------|
| 16/R1,5 x 600 x 4100 | 10012550040 |
| Iveral (mm) ST9      |             |
| 18 x 2070 x 2800     | 20030812180 |

| Kuhinjska zidna obloga (mm) ST9 |             |
|---------------------------------|-------------|
| 8 x 640 x 4100                  | 10012590200 |
| Kutna letva / setovi kutnika    |             |
| Trokutastog presjeka tip 56     | 10015802405 |
|                                 | 10015710210 |

| Laminat (mm)               |             |
|----------------------------|-------------|
| Ploča: 2800 x 1310         | 10011333040 |
| Rubna traka / narudžba: tm |             |
| Kod                        | 38860       |

## Black Pietra Grigia F206 PT

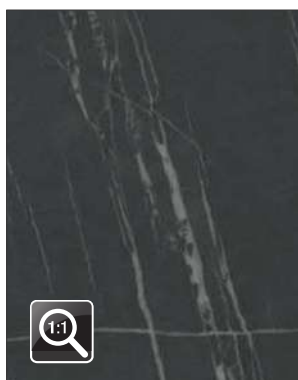

| Radna ploča (mm)     |             |
|----------------------|-------------|
| 16/R1,5 x 600 x 4100 | 10012550020 |
| Iveral (mm) ST9      |             |
| 18 x 2070 x 2800     | 20030206180 |

| Kuhinjska zidna obloga (mm) ST9 |             |
|---------------------------------|-------------|
| 8 x 640 x 4100                  | 10012590160 |
| Kutna letva / setovi kutnika    |             |
| Trokutastog presjeka tip 56     | 10015802410 |
|                                 | 10015710230 |

| Laminat (mm)               |             |
|----------------------------|-------------|
| Ploča: 2800 x 1310         | 10011333020 |
| Rubna traka / narudžba: tm |             |
| Kod                        | 38862       |

The logo for Egger, consisting of a red square with a white 'E' inside, followed by the word 'EGGER' in a bold, black, sans-serif font.

■ RADNE PLOČE I PLOČE STOLA

F206 / U702 / H3303



## Premium White W1000 ST76

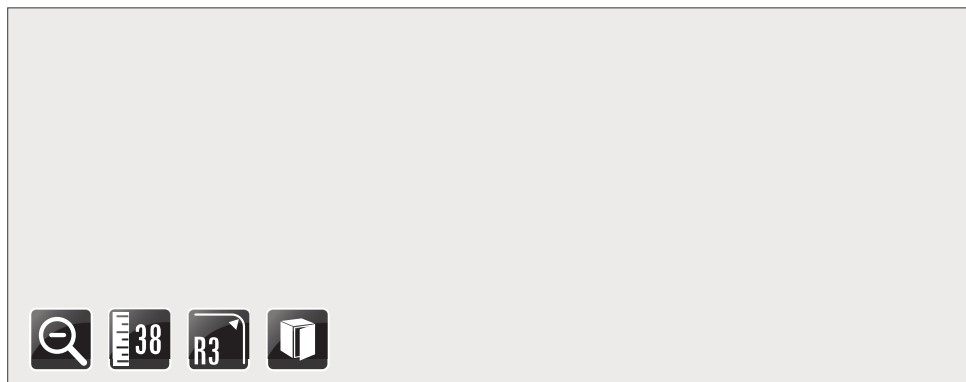
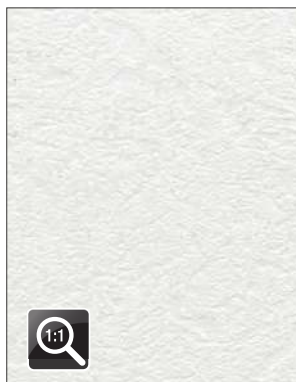

| Radna ploča (mm)   |             |
|--------------------|-------------|
| 38/R3 x 600 x 4100 | 10012553390 |
| Ploča stola (mm)   |             |
| 38/R3 x 920 x 4100 | 10001910500 |

| Iveral (mm)                  |             |
|------------------------------|-------------|
| 18 x 2070 x 2800 ST9         | 20011000180 |
| 18 x 2070 x 2800 ST19        | 20011000181 |
| 18 x 2070 x 2800 ST38        | 20011000185 |
| Kutna letva / setovi kutnika |             |
| Trokutastog presjeka tip 56  | 10015802090 |
|                              | 10015710210 |

| Laminat (mm)                |             |
|-----------------------------|-------------|
| Traka, s ljeplom: 5000 x 45 | 10005020810 |
| Ploča: 2800 x 1310          | 10011330970 |
| Rubna traka / narudžba: tm  |             |
| Kod                         | 30036       |

## Pearl Grey U763 ST76

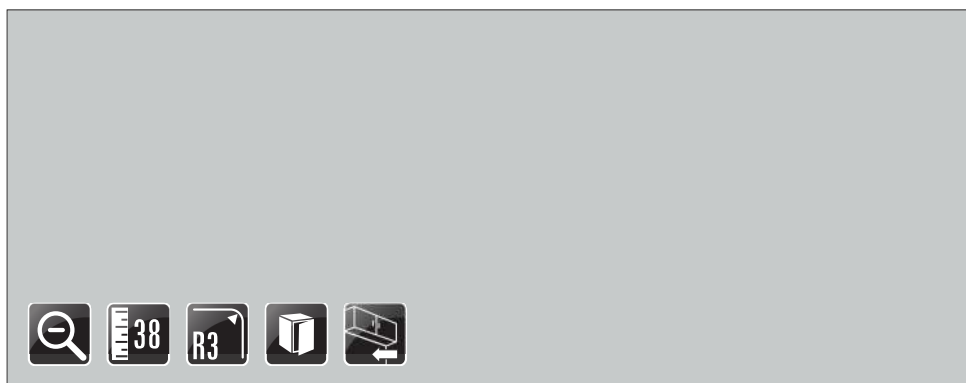
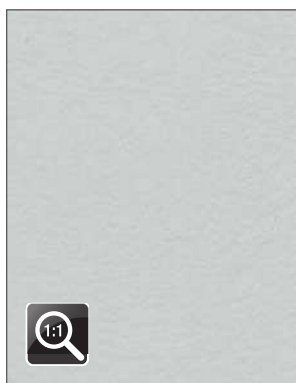

| Radna ploča (mm)            |             |
|-----------------------------|-------------|
| 38/R3 x 600 x 4100          | 10012553370 |
| Iveral (mm) ST9             |             |
| 18 x 2070 x 2800            | 20010763182 |
| Kuhinjska zidna obloga (mm) |             |
| 8 x 640 x 4100              | 10012590000 |

| Kutna letva / setovi kutnika |             |
|------------------------------|-------------|
| Trokutastog presjeka tip 56  | 10015802080 |
|                              | 10015710230 |

| Laminat (mm)                |             |
|-----------------------------|-------------|
| Traka, s ljeplom: 5000 x 45 | 10005020790 |
| Ploča: 2800 x 1310          | 10011330950 |
| Rubna traka / narudžba: tm  |             |
| Kod                         | 30111       |

## Cashmere Grey U702 ST89

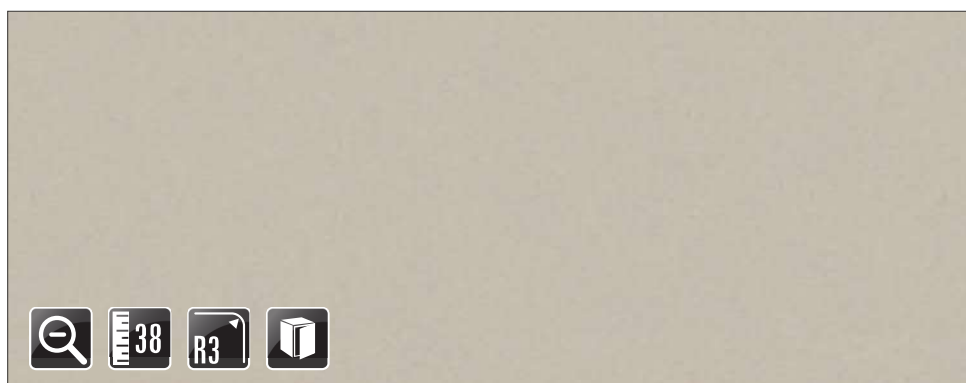
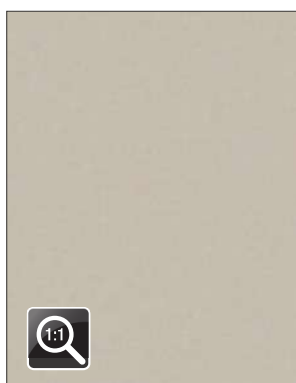

| Radna ploča (mm)   |             |
|--------------------|-------------|
| 38/R3 x 600 x 4100 | 10012553560 |
| Iveral (mm) ST9    |             |
| 18 x 2070 x 2800   | 20010702180 |

| Kutna letva / setovi kutnika |             |
|------------------------------|-------------|
| Trokutastog presjeka tip 56  | 10015802265 |
|                              | 10015710230 |

| Laminat (mm)               |             |
|----------------------------|-------------|
| Ploča: 2800 x 1310         | 10011331160 |
| Rubna traka / narudžba: tm |             |
| Kod                        | 30136       |

## Black U999 ST89

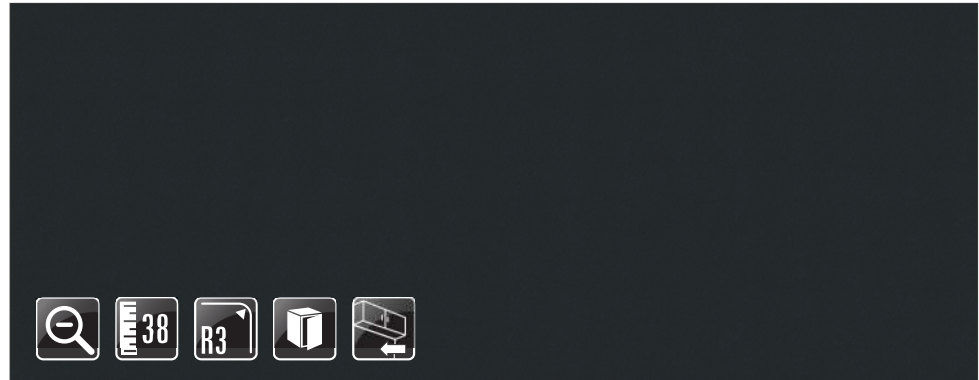
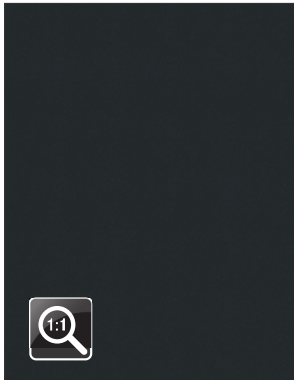

| Radna ploča (mm)   |             |
|--------------------|-------------|
| 38/R3 x 600 x 4100 | 10012554275 |
| Ploča stola (mm)   |             |
| 38/R3 x 920 x 4100 | 10001910490 |

| Iveral (mm)                 |             |
|-----------------------------|-------------|
| 2800 x 2070 x18 ST2         | 20010999180 |
| 2800 x 2070 x18 ST19        | 20010999184 |
| Kuhinjska zidna obloga (mm) |             |
| 8 x 640 x 4100              | 10012590000 |

| Kutna letva / setovi kutnika |             |
|------------------------------|-------------|
| Trokutastog presjeka         | 10015802270 |
| tip 56                       | 10015710260 |
| Laminat (mm)                 |             |
| Ploča: 2800 x 1310           | 10011330305 |
| Rubna traka / narudžba: tm   |             |
| Kod                          | 30231       |

## Titanium F501 ST2

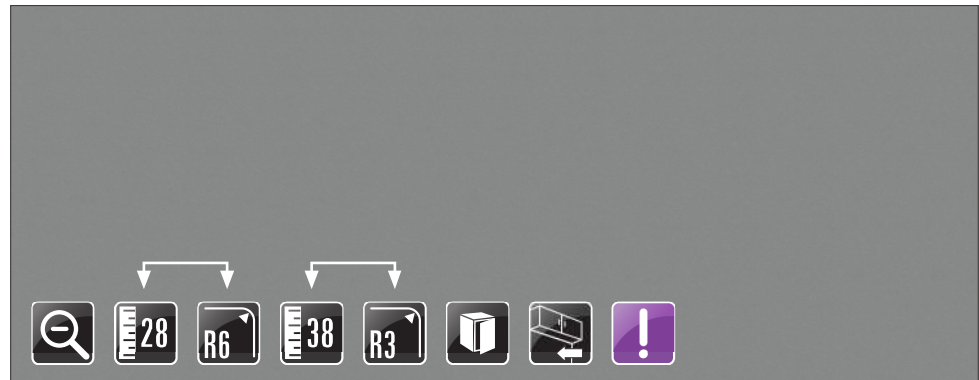
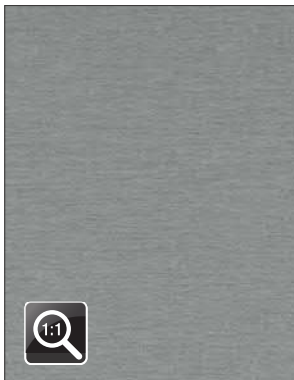

| Radna ploča (mm)    |             |
|---------------------|-------------|
| 28/R6 x 600 x 4100  | 10012551510 |
| 38/R3 x 600 x 4100  | 10012554040 |
| 38/R3 x 1200 x 4100 | 10012554670 |
| Ploča stola (mm)    |             |
| 28/R6 x 800 x 4100  | 10001910020 |
| 38/R3 x 920 x 4100  | 10001910170 |

| Iveral (mm)                  |             |
|------------------------------|-------------|
| 18 x 2070 x 2800             | 20030501180 |
| Kuhinjska zidna obloga (mm)  |             |
| 8 x 640 x 4100               | 10012590190 |
| Kutna letva / setovi kutnika |             |
| Trokutastog presjeka         | 10015801055 |
| tip 56                       | 10015710230 |

| Laminat (mm)                    |             |
|---------------------------------|-------------|
| Traka, s ljepljom:<br>5000 x 32 | 10005003110 |
| Traka, s ljepljom:<br>5000 x 45 | 10005020020 |
| Ploča: 2800 x 1310              | 10011330010 |
| Rubna traka / narudžba: tm      |             |
| Kod                             | 39000       |

## Cement F385 ST10

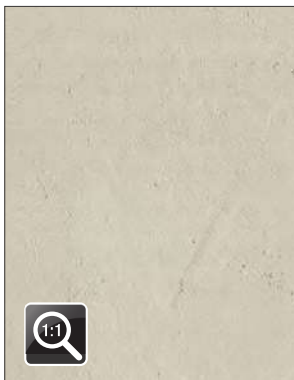

| Radna ploča (mm)   |             |
|--------------------|-------------|
| 38/R3 x 600 x 4100 | 10012554500 |
| Ploča stola (mm)   |             |
| 38/R3 x 920 x 4100 | 10001910340 |

| Kuhinjska zidna obloga (mm)  |             |
|------------------------------|-------------|
| 8 x 640 x 4100               | 10012590180 |
| Kutna letva / setovi kutnika |             |
| Trokutastog presjeka         | 10015801720 |
| tip 56                       | 10015710210 |

| Laminat (mm)                    |             |
|---------------------------------|-------------|
| Traka, s ljepljom:<br>5000 x 45 | 10005020360 |
| Ploča: 2800 x 1310              | 10011330530 |
| Rubna traka / narudžba: tm      |             |
| Kod                             | 39370       |

## White Chromix F637 ST16

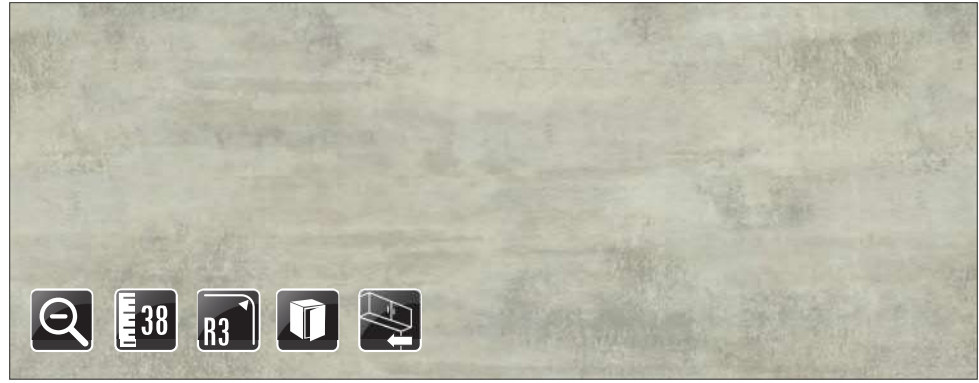
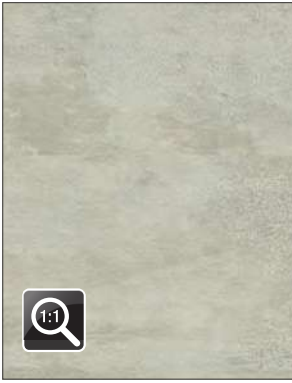

| Radna ploča (mm)   |             |
|--------------------|-------------|
| 38/R3 x 600 x 4100 | 10012553490 |
| Iveral (mm)        |             |
| 18 x 2070 x 2800   | 20030637180 |

| Kuhinjska zidna obloga (mm) ST9 |             |
|---------------------------------|-------------|
| 8 x 640 x 4100                  | 10012590250 |
| Kutna letva / setovi kutnika    |             |
| Trokutastog presjeka            | 10015802170 |
| tip 56                          | 10015710210 |

| Laminat (mm)                    |             |
|---------------------------------|-------------|
| Traka, s ljepljom:<br>5000 x 45 | 10005020900 |
| Ploča: 2800 x 1310              | 10011331090 |
| Rubna traka / narudžba: tm      |             |
| Kod                             | 39322       |

## Light Grey Chicago Concrete F186 ST9



| Radna ploča (mm)   |             |
|--------------------|-------------|
| 38/R3 x 600 x 4100 | 10012553550 |
| Ploča stola (mm)   |             |
| 38/R3 x 920 x 4100 | 10001910550 |
| Iveral (mm)        |             |
| 18 x 2070 x 2800   | 20030186180 |

| Kuhinjska zidna obloga (mm)  |             |
|------------------------------|-------------|
| 8 x 640 x 4100               | 10012590150 |
| Kutna letva / setovi kutnika |             |
| Trokutastog presjeka         | 10015802200 |
| tip 56                       | 10015710230 |

| Laminat (mm)                    |             |
|---------------------------------|-------------|
| Traka, s ljepljom:<br>5000 x 45 | 10005020960 |
| Ploča: 2800 x 1310              | 10011331150 |
| Rubna traka / narudžba: tm      |             |
| Kod                             | 39328       |

## Dark Grey Chicago Concrete F187 ST9

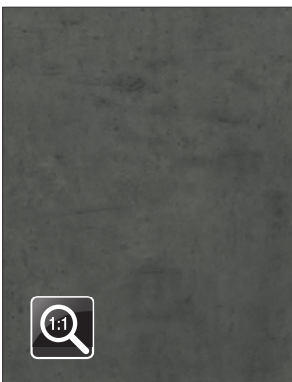

| Radna ploča (mm)            |             |
|-----------------------------|-------------|
| 38/R3 x 600 x 4100          | 10012553520 |
| Iveral (mm)                 |             |
| 18 x 2070 x 2800            | 20030187180 |
| Kuhinjska zidna obloga (mm) |             |
| 8 x 640 x 4100              | 10012590150 |

| Kutna letva / setovi kutnika |             |
|------------------------------|-------------|
| Trokutastog presjeka         | 10015802185 |
| tip 56                       | 10015710230 |

| Laminat (mm)                    |             |
|---------------------------------|-------------|
| Traka, s ljepljom:<br>5000 x 45 | 10005020930 |
| Ploča: 2800 x 1310              | 10011331120 |
| Rubna traka / narudžba: tm      |             |
| Kod                             | 39329       |



## Dark Concrete F275 ST9



| Radna ploča (mm)     |             |
|----------------------|-------------|
| 38/R3 x 600 x 4100   | 10012554140 |
| 38/R3 x 1200 x 4100  | 10012554720 |
| Ploča stola (mm)     |             |
| 38/2*R3 x 920 x 4100 | 10001910220 |

| Kutna letva / setovi kutnika |             |
|------------------------------|-------------|
| Trokutastog presjeka         | 10015801195 |
| tip 56                       | 10015710260 |

| Laminat (mm)                    |             |
|---------------------------------|-------------|
| Traka, s ljepljom:<br>5000 x 45 | 10005020070 |
| Ploča: 2800 x 1310              | 10011330120 |
| Rubna traka / narudžba: tm      |             |
| Kod                             | 39331       |

## Chalk Ceramic F312 ST87

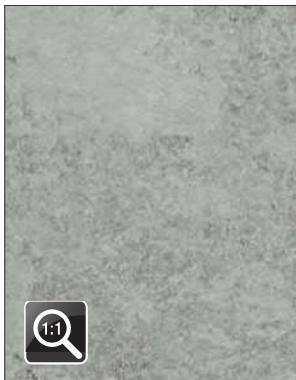

| Radna ploča (mm)   |             |
|--------------------|-------------|
| 38/R3 x 600 x 4100 | 10012553070 |

| Kutna letva / setovi kutnika |             |
|------------------------------|-------------|
| Trokutastog presjeka         | 10015801835 |
| tip 56                       | 10015710230 |

| Laminat (mm)                    |             |
|---------------------------------|-------------|
| Traka, s ljepljom:<br>5000 x 45 | 10005020490 |
| Ploča: 2800 x 1310              | 10011330620 |

## Grey-Bež Galizia Granite F371 ST89

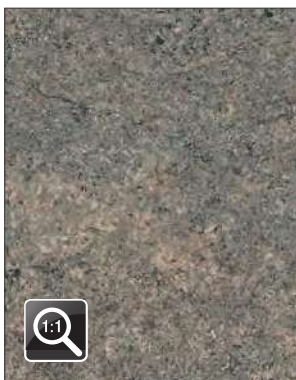

| Radna ploča (mm)   |             |
|--------------------|-------------|
| 38/R3 x 600 x 4100 | 10012553770 |

| Kutna letva / setovi kutnika |             |
|------------------------------|-------------|
| Trokutastog presjeka         | 10015802335 |
| tip 56                       | 10015710230 |

| Laminat (mm)               |             |
|----------------------------|-------------|
| Ploča: 2800 x 1310         | 10011331370 |
| Rubna traka / narudžba: tm |             |
| Kod                        | 39377       |

## Cream Tessina F221 ST87

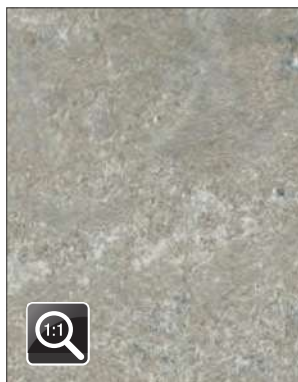

| Radna ploča (mm)            |             |
|-----------------------------|-------------|
| 38/R3 x 600 x 4100          | 10012553020 |
| Kuhinjska zidna obloga (mm) |             |
| 8 x 640 x 4100              | 10012590160 |

| Kutna letva / setovi kutnika |             |
|------------------------------|-------------|
| Trokutastog presjeka         | 10015801810 |
| tip 56                       | 10015710220 |

| Laminat (mm)                    |             |
|---------------------------------|-------------|
| Traka, s ljepljom:<br>5000 x 45 | 10005020440 |
| Ploča: 2800 x 1310              | 10011330640 |
| Rubna traka / narudžba: tm      |             |
| Kod                             | 39383       |

## White Sonora Stone F041 ST15

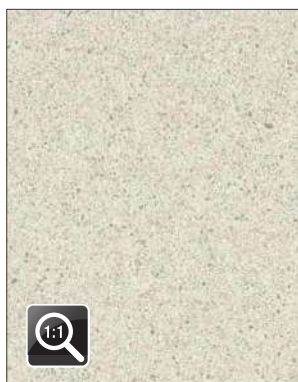

| Radna ploča (mm)   |             |
|--------------------|-------------|
| 38/R3 x 600 x 4100 | 10012553500 |

| Kutna letva / setovi kutnika |             |
|------------------------------|-------------|
| Trokutastog presjeka         | 10015802175 |
| tip 56                       | 10015710210 |

| Laminat (mm)                    |             |
|---------------------------------|-------------|
| Traka, s ljepljom:<br>5000 x 45 | 10005020910 |
| Ploča: 2800 x 1310              | 10011331100 |
| Rubna traka / narudžba: tm      |             |
| Kod                             | 39378       |

## Black Ventura Stone F117 ST76



| Radna ploča (mm)   |             |
|--------------------|-------------|
| 38/R3 x 600 x 4100 | 10012553540 |

| Kutna letva / setovi kutnika |             |
|------------------------------|-------------|
| Trokutastog presjeka         | 10015802195 |
| tip 56                       | 10015710260 |

| Laminat (mm)                    |             |
|---------------------------------|-------------|
| Traka, s ljepljom:<br>5000 x 45 | 10005020950 |
| Ploča: 2800 x 1310              | 10011331140 |
| Rubna traka / narudžba: tm      |             |
| Kod                             | 39414       |

## Rusty Sparkle Grain F484 ST87

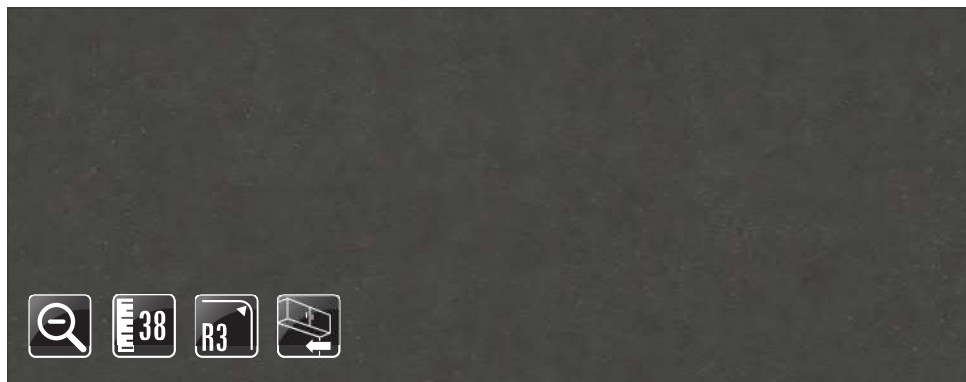
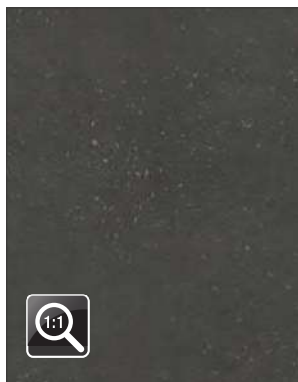

| Radna ploča (mm)            |             |
|-----------------------------|-------------|
| 38/R3 x 600 x 4100          | 10012553780 |
| Kuhinjska zidna obloga (mm) |             |
| 8 x 640 x 4100              | 10012590190 |

| Kutna letva / setovi kutnika |             |
|------------------------------|-------------|
| Trokutastog presjeka         | 10015802340 |
| tip 56                       | 10015710230 |

| Laminat (mm)               |             |
|----------------------------|-------------|
| Ploča: 2800 x 1310         | 10011331380 |
| Rubna traka / narudžba: tm |             |
| Kod                        | 39334       |

## Brown Fine Granite F148 ST89

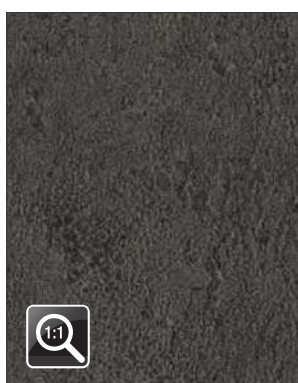

| Radna ploča (mm)   |             |
|--------------------|-------------|
| 38/R3 x 600 x 4100 | 10012553211 |

| Kutna letva / setovi kutnika |             |
|------------------------------|-------------|
| Trokutastog presjeka         | 10015802001 |
| tip 56                       | 10015710220 |

| Laminat (mm)                   |             |
|--------------------------------|-------------|
| Traka, s ljeplom:<br>5000 x 45 | 10005020631 |
| Ploča: 2800 x 1310             | 10011330811 |

## Antracite Vercelli Granite F028 ST89



| Radna ploča (mm)            |             |
|-----------------------------|-------------|
| 38/R3 x 600 x 4100          | 10012553530 |
| Kuhinjska zidna obloga (mm) |             |
| 8 x 640 x 4100              | 10012590090 |

| Kutna letva / setovi kutnika |             |
|------------------------------|-------------|
| Trokutastog presjeka         | 10015802190 |
| tip 56                       | 10015710260 |

| Laminat (mm)                   |             |
|--------------------------------|-------------|
| Traka, s ljeplom:<br>5000 x 45 | 10005020940 |
| Ploča: 2800 x 1310             | 10011331130 |
| Rubna traka / narudžba: tm     |             |
| Kod                            | 39385       |



## Ferro Bronze F302 ST87

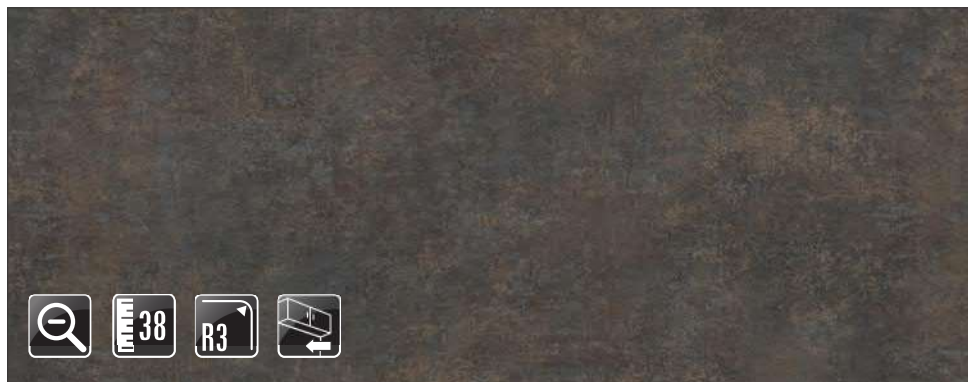

| Radna ploča (mm)            |             |
|-----------------------------|-------------|
| 38/R3 x 600 x 4100          | 10012553510 |
| Kuhinjska zidna obloga (mm) |             |
| 8 x 640 x 4100              | 10012590170 |

| Kutna letva / setovi kutnika |             |
|------------------------------|-------------|
| Trokutastog presjeka         | 10015802180 |
| tip 56                       | 10015710230 |

| Laminat (mm)                    |             |
|---------------------------------|-------------|
| Traka, s ljepljom:<br>5000 x 45 | 10005020920 |
| Ploča: 2800 x 1310              | 10011331110 |
| Rubna traka / narudžba: tm      |             |
| Kod                             | 39336       |

## Rust Ceramic F310 ST87

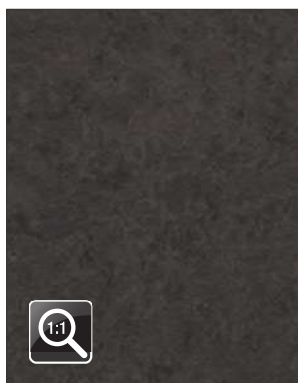

| Radna ploča (mm)   |             |
|--------------------|-------------|
| 38/R3 x 600 x 4100 | 10012553050 |

| Kutna letva / setovi kutnika |             |
|------------------------------|-------------|
| Trokutastog presjeka         | 10015801825 |
| tip 56                       | 10015710270 |

| Laminat (mm)                    |             |
|---------------------------------|-------------|
| Traka, s ljepljom:<br>5000 x 45 | 10005020470 |
| Ploča: 2800 x 1310              | 10011330600 |

## Anthracite Ceramic F311 ST87

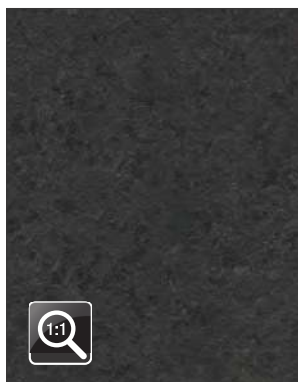

| Radna ploča (mm)            |             |
|-----------------------------|-------------|
| 38/R3 x 600 x 4100          | 10012553060 |
| Kuhinjska zidna obloga (mm) |             |
| 8 x 640 x 4100              | 10012590170 |

| Kutna letva / setovi kutnika |             |
|------------------------------|-------------|
| Trokutastog presjeka         | 10015801830 |
| tip 56                       | 10015710260 |

| Laminat (mm)                    |             |
|---------------------------------|-------------|
| Traka, s ljepljom:<br>5000 x 45 | 10005020480 |
| Ploča: 2800 x 1310              | 10011330610 |
| Rubna traka / narudžba: tm      |             |
| Kod                             | 39333       |

## Grey Ornamental Concrete F333 ST76



| Radna ploča (mm)   |             |
|--------------------|-------------|
| 38/R3 x 600 x 4100 | 10012553760 |

| Kutna letva / setovi kutnika |             |
|------------------------------|-------------|
| Trokutastog presjeka         | 10015802330 |
| tip 56                       | 10015710230 |

| Laminat (mm)               |             |
|----------------------------|-------------|
| Ploča: 2800 x 1310         | 10011331360 |
| Rubna traka / narudžba: tm |             |
| Kod                        | 39324       |

## Anthracite Jura Slate F242 ST10



| Radna ploča (mm)            |             |
|-----------------------------|-------------|
| 38/R3 x 600 x 4100          | 10012553750 |
| Kuhinjska zidna obloga (mm) |             |
| 8 x 640 x 4100              | 10012590240 |

| Kutna letva / setovi kutnika |             |
|------------------------------|-------------|
| Trokutastog presjeka         | 10015802325 |
| tip 56                       | 10015710230 |

| Laminat (mm)               |             |
|----------------------------|-------------|
| Ploča: 2800 x 1310         | 10011331350 |
| Rubna traka / narudžba: tm |             |
| Kod                        | 39335       |

## Black Vintage Hessian F508 ST10

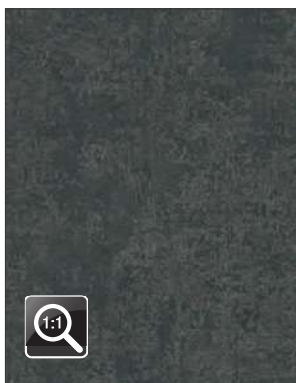

| Radna ploča (mm)   |             |
|--------------------|-------------|
| 38/R3 x 600 x 4100 | 10012553790 |

| Kutna letva / setovi kutnika |             |
|------------------------------|-------------|
| Trokutastog presjeka         | 10015802345 |
| tip 56                       | 10015710260 |

| Laminat (mm)               |             |
|----------------------------|-------------|
| Ploča: 2800 x 1310         | 10011331390 |
| Rubna traka / narudžba: tm |             |
| Kod                        | 39445       |

## Latina Marble F104 ST2



| Radna ploča (mm)   |             |
|--------------------|-------------|
| 38/R3 x 600 x 4100 | 10012553470 |
| Ploča stola (mm)   |             |
| 38/R3 x 920 x 4100 | 10001910540 |

| Kuhinjska zidna obloga (mm)  |             |
|------------------------------|-------------|
| 8 x 640 x 4100               | 10012590220 |
| Kutna letva / setovi kutnika |             |
| Trokutastog presjeka tip 56  | 10015802160 |
|                              | 10015710230 |

| Laminat (mm)                   |             |
|--------------------------------|-------------|
| Traka, s ljepljivom: 5000 x 45 | 10005020880 |
| Ploča: 2800 x 1310             | 10011331070 |
| Rubna traka / narudžba: tm     |             |
| Kod                            | 39423       |

## Tivoli Bež F292 ST9

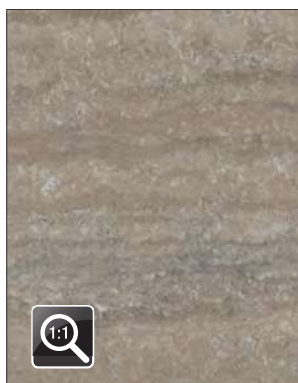

| Radna ploča (mm)            |             |
|-----------------------------|-------------|
| 38/R3 x 600 x 4100          | 10012554380 |
| Ploča stola (mm)            |             |
| 38/2*R3 x 920 x 4100        | 10001910400 |
| Kuhinjska zidna obloga (mm) |             |
| 8 x 640 x 4100              | 10012590060 |

| Kutna letva / setovi kutnika |             |
|------------------------------|-------------|
| Trokutastog presjeka tip 56  | 10015801660 |
|                              | 10015710220 |

| Laminat (mm)                   |             |
|--------------------------------|-------------|
| Traka, s ljepljivom: 5000 x 45 | 10005020240 |
| Ploča: 2800 x 1310             | 10011330410 |
| Rubna traka / narudžba: tm     |             |
| Kod                            | 39376       |

## White Levanto Marble F812 ST9

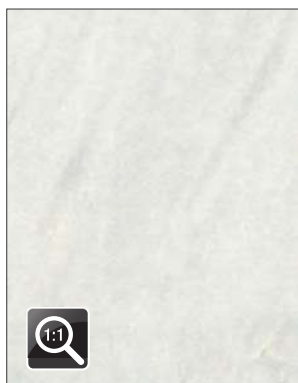

| Radna ploča / Ploča stola (mm) |             |
|--------------------------------|-------------|
| 38/R3 x 600 x 4100             | 10012553480 |
| Iveral (mm)                    |             |
| 18 x 2070 x 2800               | 20030812180 |
| Kuhinjska zidna obloga (mm)    |             |
| 8 x 640 x 4100                 | 10012590200 |

| Kutna letva / setovi kutnika |             |
|------------------------------|-------------|
| Trokutastog presjeka tip 56  | 10015802165 |
|                              | 10015710210 |

| Laminat (mm)                   |             |
|--------------------------------|-------------|
| Traka, s ljepljivom: 5000 x 45 | 10005020890 |
| Ploča: 2800 x 1310             | 10011331080 |
| Rubna traka / narudžba: tm     |             |
| Kod                            | 39432       |



## White Carrara Marble F204 ST75



| Radna ploča (mm)   |             |
|--------------------|-------------|
| 38/R3 x 600 x 4100 | 10012553720 |
| Iveral (mm) ST9    |             |
| 18 x 2070 x 2800   | 20030204180 |

| Kuhinjska zidna obloga (mm)  |             |
|------------------------------|-------------|
| 8 x 640 x 4100               | 10012590230 |
| Kutna letva / setovi kutnika |             |
| Trokutastog presjeka tip 56  | 10015802310 |
|                              | 10015710210 |

| Laminat (mm)               |             |
|----------------------------|-------------|
| Ploča: 2800 x 1310         | 10011331320 |
| Rubna traka / narudžba: tm |             |
| Kod                        | 39437       |

## Black Marble F202 ST15

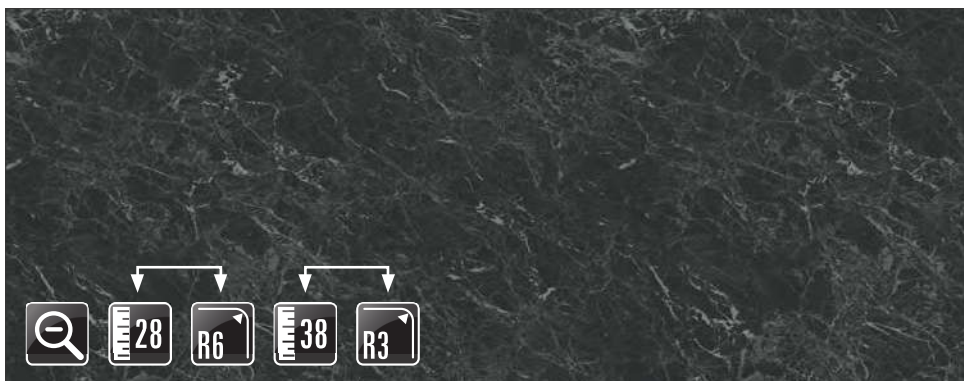
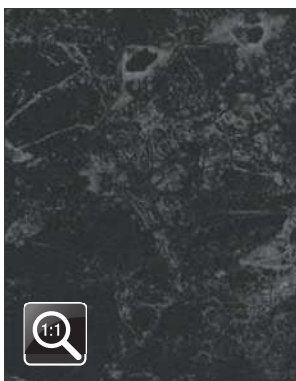

| Radna ploča (mm)   |             |
|--------------------|-------------|
| 28/R6 x 600 x 4100 | 10012551460 |
| 38/R3 x 600 x 4100 | 10012554010 |

| Kutna letva / setovi kutnika |             |
|------------------------------|-------------|
| Trokutastog presjeka tip 56  | 10015801030 |
|                              | 10015710260 |

| Laminat (mm)                 |             |
|------------------------------|-------------|
| Traka, s ljepljom: 5000 x 32 | 10005003060 |
| Traka, s ljepljom: 5000 x 45 | 10005020005 |
| Ploča: 2800 x 1310           | 10011330090 |

## Anthracite Pietra Grigia F205 ST9

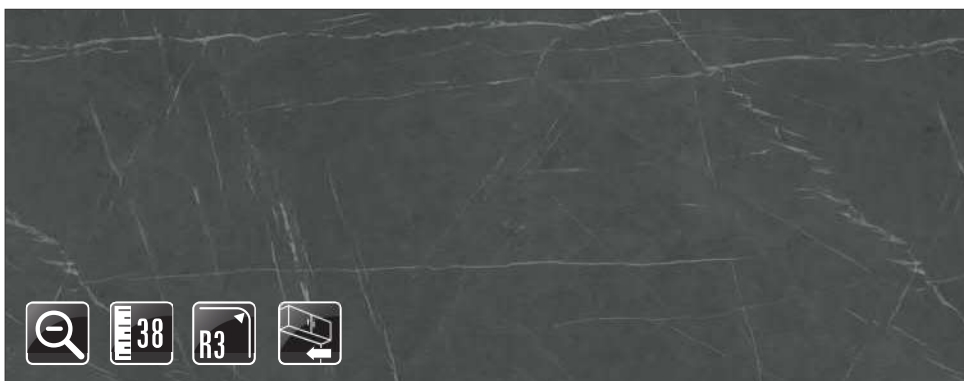

| Radna ploča (mm)            |             |
|-----------------------------|-------------|
| 38/R3 x 600 x 4100          | 10012553730 |
| Kuhinjska zidna obloga (mm) |             |
| 8 x 640 x 4100              | 10012590230 |

| Kutna letva / setovi kutnika |             |
|------------------------------|-------------|
| Trokutastog presjeka tip 56  | 10015802315 |
|                              | 10015710230 |

| Laminat (mm)               |             |
|----------------------------|-------------|
| Ploča: 2800 x 1310         | 10011331330 |
| Rubna traka / narudžba: tm |             |
| Kod                        | 39438       |

## Black Pietra Grigia F206 ST9



| Radna ploča (mm)   |             |
|--------------------|-------------|
| 38/R3 x 600 x 4100 | 10012553740 |
| Iveral (mm)        |             |
| 18 x 2070 x 2800   | 20030206180 |

| Kuhinjska zidna obloga (mm)  |             |
|------------------------------|-------------|
| 8 x 640 x 4100               | 10012590160 |
| Kutna letva / setovi kutnika |             |
| Trokutastog presjeka tip 56  | 10015802320 |
|                              | 10015710230 |

| Laminat (mm)               |             |
|----------------------------|-------------|
| Ploča: 2800 x 1310         | 10011331340 |
| Rubna traka / narudžba: tm |             |
| Kod                        | 39439       |

## Grey Florence Marble F112 ST9



| Radna ploča (mm)            |             |
|-----------------------------|-------------|
| 38/R3 x 600 x 4100          | 10012553700 |
| Kuhinjska zidna obloga (mm) |             |
| 8 x 640 x 4100              | 10012590180 |

| Kutna letva / setovi kutnika |             |
|------------------------------|-------------|
| Trokutastog presjeka tip 56  | 10015802300 |
|                              | 10015710230 |

| Laminat (mm)               |             |
|----------------------------|-------------|
| Ploča: 2800 x 1310         | 10011331300 |
| Rubna traka / narudžba: tm |             |
| Kod                        | 39424       |

## Grey Magma Granite F011 ST9

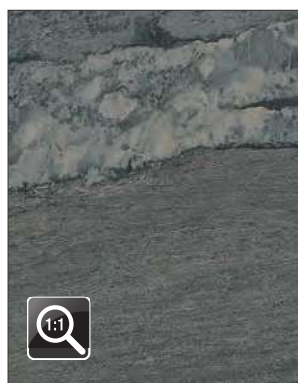

| Radna ploča (mm)   |             |
|--------------------|-------------|
| 38/R3 x 600 x 4100 | 10012553650 |

| Kutna letva / setovi kutnika |             |
|------------------------------|-------------|
| Trokutastog presjeka tip 56  | 10015802275 |
|                              | 10015710230 |

| Laminat (mm)               |             |
|----------------------------|-------------|
| Ploča: 2800 x 1310         | 10011331250 |
| Rubna traka / narudžba: tm |             |
| Kod                        | 39420       |



## Red Magma Granite F012 ST9

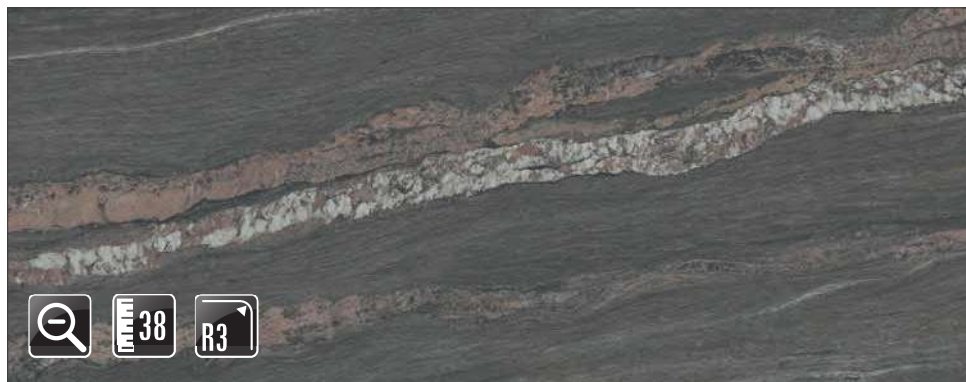
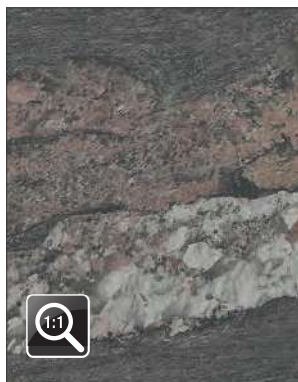

| Radna ploča (mm)   |             |
|--------------------|-------------|
| 38/R3 x 600 x 4100 | 10012553660 |

| Kutna letva / setovi kutnika |             |
|------------------------------|-------------|
| Trokutastog presjeka         | 10015802280 |
| tip 56                       | 10015710220 |

| Laminat (mm)               |             |
|----------------------------|-------------|
| Ploča: 2800 x 1310         | 10011331260 |
| Rubna traka / narudžba: tm |             |
| Kod                        | 39421       |

## Engelsberg Marble F014 ST9

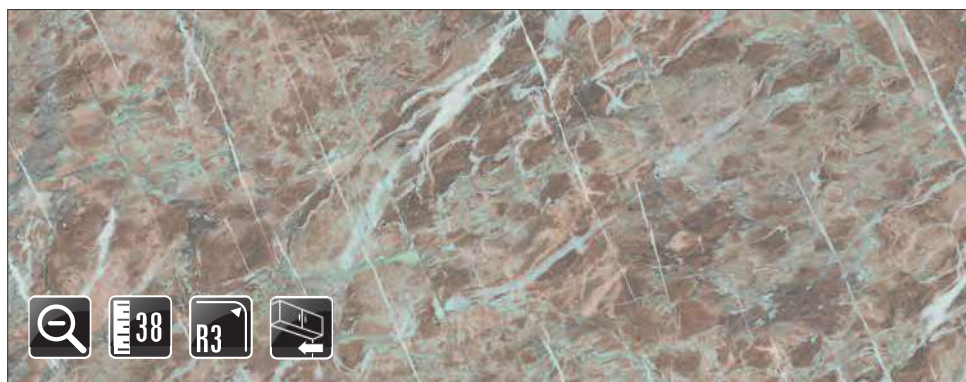
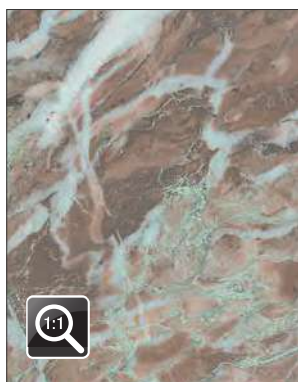

| Radna ploča (mm)            |             |
|-----------------------------|-------------|
| 38/R3 x 600 x 4100          | 10012553670 |
| Kuhinjska zidna obloga (mm) |             |
| 8 x 640 x 4100              | 10012590140 |

| Kutna letva / setovi kutnika |             |
|------------------------------|-------------|
| Trokutastog presjeka         | 10015802285 |
| tip 56                       | 10015710230 |

| Laminat (mm)               |             |
|----------------------------|-------------|
| Ploča: 2800 x 1310         | 10011331270 |
| Rubna traka / narudžba: tm |             |
| Kod                        | 39411       |

## Grey Cipollino Marble F093 ST15



S ravnostrtno porubljenim rubom

| Radna ploča (mm)            |             |
|-----------------------------|-------------|
| 38/R3 x 600 x 4100          | 10012553170 |
| Kuhinjska zidna obloga (mm) |             |
| 8 x 640 x 4100              | 10012590070 |

| Kutna letva / setovi kutnika |             |
|------------------------------|-------------|
| Trokutastog presjeka         | 10015801980 |
| tip 56                       | 10015710220 |

| Laminat (mm)                    |             |
|---------------------------------|-------------|
| Traka, s ljepljom:<br>5000 x 45 | 10005020590 |
| Ploča: 2800 x 1310              | 10011330770 |
| Rubna traka / narudžba: tm      |             |
| Kod                             | 39427       |





F093

## ■ Black Copper Cipollino Marble F094 ST15

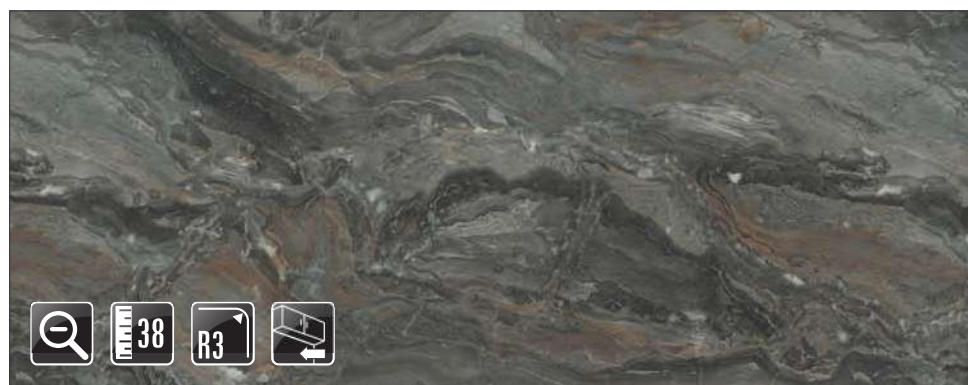

| Radna ploča (mm)            |             |
|-----------------------------|-------------|
| 38/R3 x 600 x 4100          | 10012553180 |
| Kuhinjska zidna obloga (mm) |             |
| 8 x 640 x 4100              | 10012590020 |

| Kutna letva / setovi kutnika |             |
|------------------------------|-------------|
| Trokutastog presjeka tip 56  | 10015801985 |
|                              | 10015710240 |

| Laminat (mm)                 |             |
|------------------------------|-------------|
| Traka, s ljepljom: 5000 x 45 | 10005020600 |
| Ploča: 2800 x 1310           | 10011330780 |
| Rubna traka / narudžba: tm   |             |
| Kod                          | 39429       |

## Grey Triestino Terrazzo F021 ST75

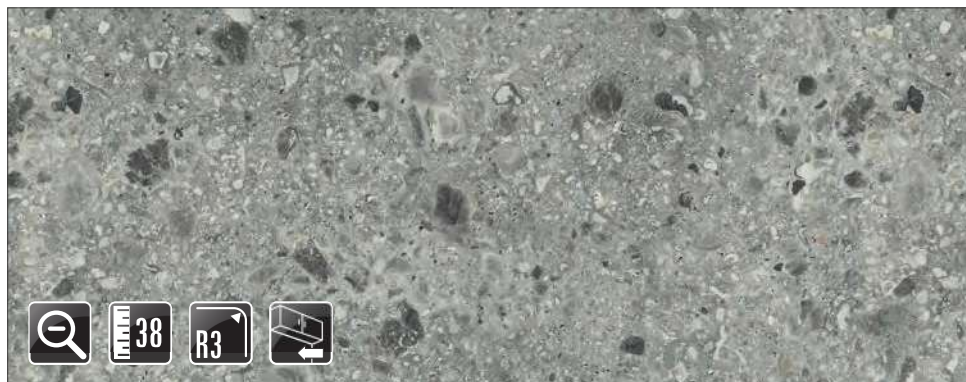

| Radna ploča (mm)            |             |
|-----------------------------|-------------|
| 38/R3 x 600 x 4100          | 10012553680 |
| Kuhinjska zidna obloga (mm) |             |
| 8 x 640 x 4100              | 10012590140 |

| Kutna letva / setovi kutnika |             |
|------------------------------|-------------|
| Trokutastog presjeka         | 10015802290 |
| tip 56                       | 10015710230 |

| Laminat (mm)               |             |
|----------------------------|-------------|
| Ploča: 2800 x 1310         | 10011331280 |
| Rubna traka / narudžba: tm |             |
| Kod                        | 39412       |

## Grey Siena Marble F095 ST87



| Radna ploča (mm)   |             |
|--------------------|-------------|
| 38/R3 x 600 x 4100 | 10012553690 |

| Kutna letva / setovi kutnika |             |
|------------------------------|-------------|
| Trokutastog presjeka         | 10015802295 |
| tip 56                       | 10015710230 |

| Laminat (mm)               |             |
|----------------------------|-------------|
| Ploča: 2800 x 1310         | 10011331290 |
| Rubna traka / narudžba: tm |             |
| Kod                        | 39413       |

## Anthracite Metal Rock F121 ST87

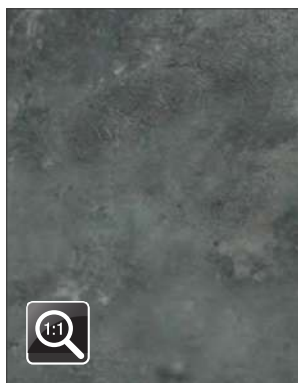

| Radna ploča (mm)   |             |
|--------------------|-------------|
| 38/R3 x 600 x 4100 | 10012553710 |

| Kutna letva / setovi kutnika |             |
|------------------------------|-------------|
| Trokutastog presjeka         | 10015802305 |
| tip 56                       | 10015710230 |

| Laminat (mm)               |             |
|----------------------------|-------------|
| Ploča: 2800 x 1310         | 10011331310 |
| Rubna traka / narudžba: tm |             |
| Kod                        | 39393       |



## FeelWood radne ploče



Površina radne ploče odražava realni izgled površine drveta zbog tehnologije sinkronizacije slike i otiska na površini ploče (obrada ST28 i ST37). Kompletan izgled drveta može se dobiti pomoću rubne trake sa dekorom poprečnog presjeka goda.

## White Halifax Oak H1176 ST37

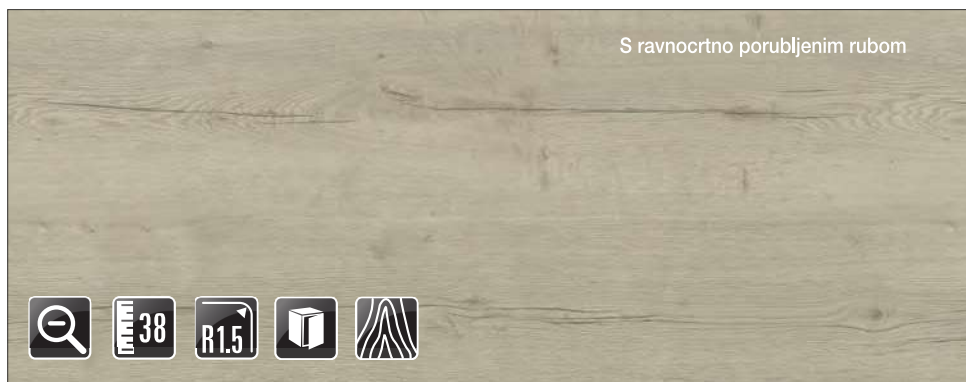
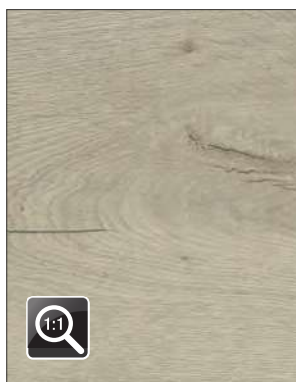

| Radna ploča (mm)     |             |
|----------------------|-------------|
| 38/R1,5 x 600 x 4100 | 10012553420 |
| Iveral (mm)          |             |
| 18 x 2070 x 2800     | 20021176180 |

| Laminat (mm)       |             |
|--------------------|-------------|
| Ploča: 2790 x 2060 | 10011331020 |

| Rubna traka / narudžba: tm |       |
|----------------------------|-------|
| Kod                        | 34594 |

## Natural Halifax Oak H1180 ST37

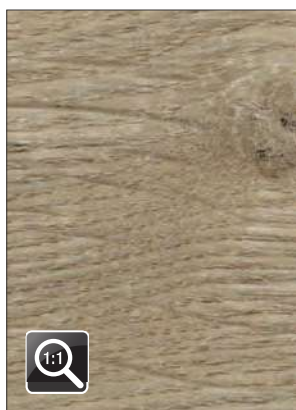

| Radna ploča (mm)     |             |
|----------------------|-------------|
| 38/R1,5 x 600 x 4100 | 10012553080 |
| Iveral (mm)          |             |
| 18 x 2070 x 2800     | 20021180180 |

| Kuhinjska zidna obloga (mm)  |             |
|------------------------------|-------------|
| 8 x 640 x 4100               | 10012590030 |
| Kutna letva / setovi kutnika |             |
| Trokutastog presjeka tip 56  | 10015802415 |
|                              | 10015710240 |

| Laminat (mm)               |             |
|----------------------------|-------------|
| Ploča: 2790 x 2060         | 10011330650 |
| Rubna traka / narudžba: tm |             |
| I FeelWood / Kod           | 34607       |



## FeelWood radne ploče



## Tobacco Halifax Oak H1181 ST37

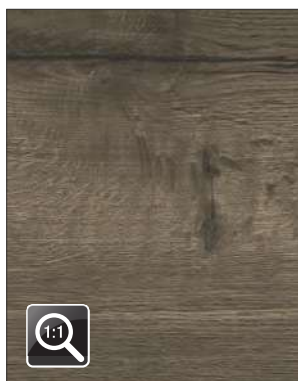

| Radna ploča (mm)            |             |
|-----------------------------|-------------|
| 38/R1,5 x 600 x 4100        | 10012553090 |
| Iveral (mm)                 |             |
| 18 x 2070 x 2800            | 20021181180 |
| Kuhinjska zidna obloga (mm) |             |
| 8 x 640 x 4100              | 10012590040 |

| Kutna letva / setovi kutnika |             |
|------------------------------|-------------|
| Trokutastog presjeka tip 56  | 10015802420 |
|                              | 10015710240 |

| Laminat (mm)               |             |
|----------------------------|-------------|
| Ploča: 2790 x 2060         | 10011330660 |
| Rubna traka / narudžba: tm |             |
| I FeelWood / Kod           | 34763       |

## Cognac Brown Sherman Oak H1344 ST32



| Radna ploča (mm)     |             |
|----------------------|-------------|
| 38/R1,5 x 600 x 4100 | 10012553120 |
| Iveral (mm)          |             |
| 18 x 2070 x 2800     | 20021344180 |

| Kutna letva / setovi kutnika |             |
|------------------------------|-------------|
| Trokutastog presjeka tip 56  | 10015802425 |
|                              | 10015710260 |

| Laminat (mm)               |             |
|----------------------------|-------------|
| Ploča: 2790 x 2060         | 10011330690 |
| Rubna traka / narudžba: tm |             |
| Kod                        | 34714       |

## Pewter Halifax Oak H3176 ST37

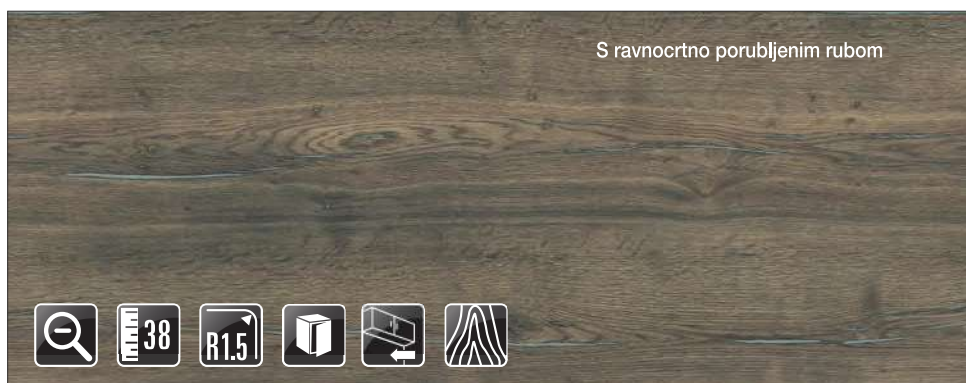
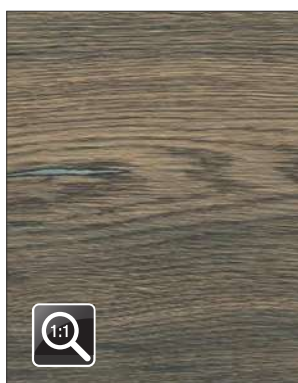

| Radna ploča (mm)     |             |
|----------------------|-------------|
| 38/R1,5 x 600 x 4100 | 10012553130 |
| Iveral (mm)          |             |
| 18 x 2070 x 2800     | 20023176180 |

| Kuhinjska zidna obloga (mm)  |             |
|------------------------------|-------------|
| 8 x 640 x 4100               | 10012590100 |
| Kutna letva / setovi kutnika |             |
| Trokutastog presjeka tip 56  | 10015802430 |
|                              | 10015710260 |

| Laminat (mm)               |             |
|----------------------------|-------------|
| Ploča: 2790 x 2060         | 10011330700 |
| Rubna traka / narudžba: tm |             |
| Kod                        | 34787       |

## Natural Hickory H3730 ST10

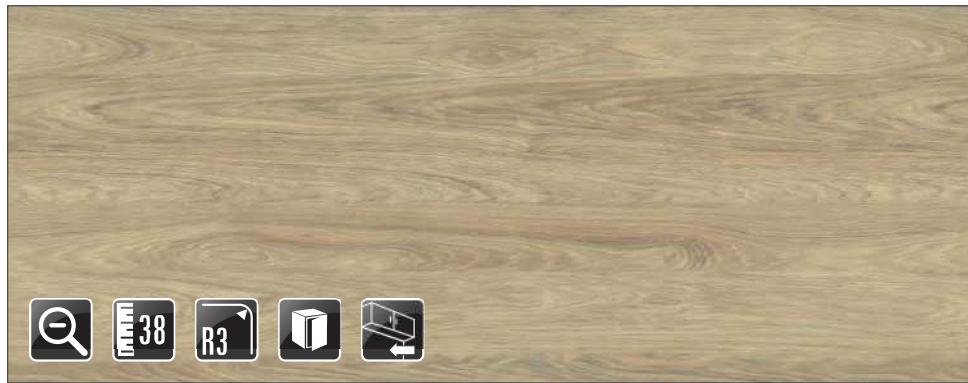
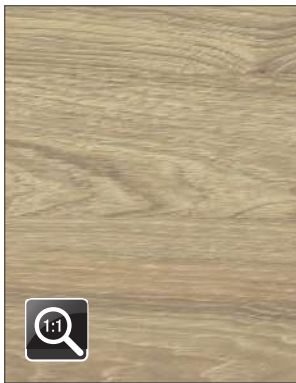

| Radna ploča (mm)   |             |
|--------------------|-------------|
| 38/R3 x 600 x 4100 | 10012553400 |
| Ploča stola (mm)   |             |
| 38/R3 x 920 x 4100 | 10001910530 |
| Iveral (mm)        |             |
| 18 x 2070 x 2800   | 20023730180 |

| Kuhinjska zidna obloga (mm)  |             |
|------------------------------|-------------|
| 8 x 640 x 4100               | 10012590220 |
| Kutna letva / setovi kutnika |             |
| Trokutastog presjeka         | 10015802130 |
| tip 56                       | 10015710240 |

| Laminat (mm)                      |             |
|-----------------------------------|-------------|
| Traka, s ljepljivom:<br>5000 x 45 | 10005020820 |
| Ploča: 2800 x 1310                | 10011331000 |
| Rubna traka / narudžba: tm        |             |
| Kod                               | 35885       |

## Natural Hamilton Oak H3303 ST10

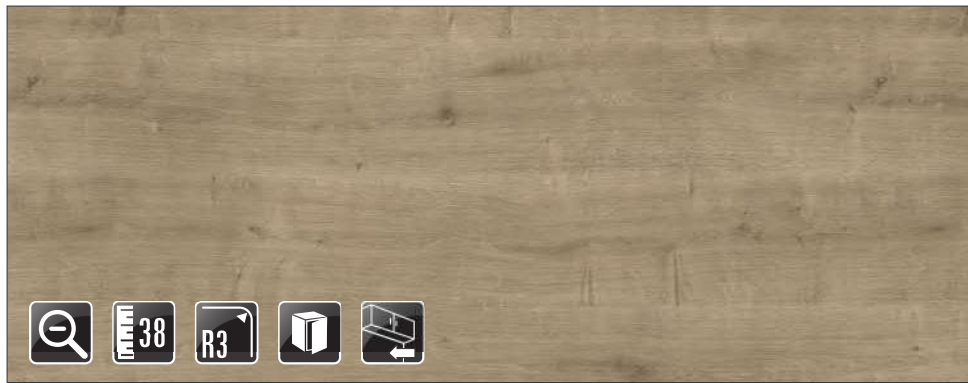

| Radna ploča (mm)     |             |
|----------------------|-------------|
| 38/R3 x 600 x 4100   | 10012553320 |
| Ploča stola (mm)     |             |
| 38/2*R3 x 920 x 4100 | 10001910390 |
| Iveral (mm)          |             |
| 18 x 2070 x 2800     | 20023303180 |

| Kuhinjska zidna obloga (mm)  |             |
|------------------------------|-------------|
| 8 x 640 x 4100               | 10012590210 |
| Kutna letva / setovi kutnika |             |
| Trokutastog presjeka         | 10015802055 |
| tip 56                       | 10015710240 |

| Laminat (mm)                      |             |
|-----------------------------------|-------------|
| Traka, s ljepljivom:<br>5000 x 45 | 10005020740 |
| Ploča: 2800 x 1310                | 10011330900 |
| Rubna traka / narudžba: tm        |             |
| Kod                               | 34615       |

## Natural Wild Oak H1318 ST10

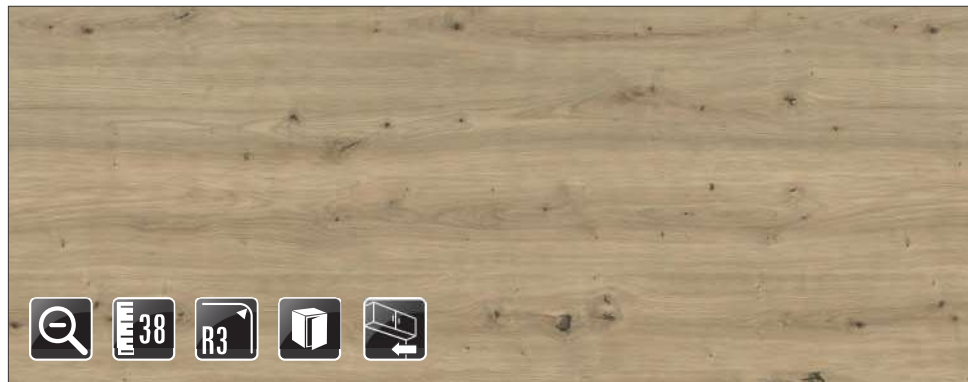
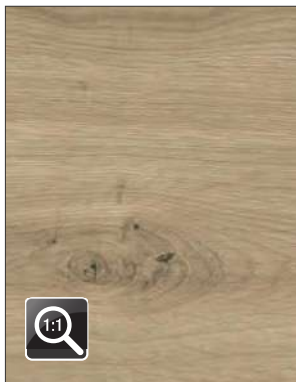

| Radna ploča (mm)   |             |
|--------------------|-------------|
| 38/R3 x 600 x 4100 | 10012553630 |
| Iveral (mm)        |             |
| 18 x 2070 x 2800   | 20021318180 |

| Kuhinjska zidna obloga (mm)  |             |
|------------------------------|-------------|
| 8 x 640 x 4100               | 10012590050 |
| Kutna letva / setovi kutnika |             |
| Trokutastog presjeka         | 10015802380 |
| tip 56                       | 10015710240 |

| Laminat (mm)               |             |
|----------------------------|-------------|
| Ploča: 2800 x 1310         | 10011331230 |
| Rubna traka / narudžba: tm |             |
| Kod                        | 34641       |



## Natural Bardolino Oak H1145 ST10



| Radna ploča (mm)     |             |
|----------------------|-------------|
| 38/R3 x 600 x 4100   | 10012554410 |
| Ploča stola (mm)     |             |
| 38/2*R3 x 920 x 4100 | 10001910410 |
| Iveral (mm)          |             |
| 18 x 2070 x 2800     | 20021145180 |

| Kuhinjska zidna obloga (mm)  |             |
|------------------------------|-------------|
| 8 x 640 x 4100               | 10012590020 |
| Kutna letva / setovi kutnika |             |
| Trokutastog presjeka         | 10015801675 |
| tip 56                       | 10015710220 |

| Laminat (mm)                    |             |
|---------------------------------|-------------|
| Traka, s ljepljom:<br>5000 x 45 | 10005020270 |
| Ploča: 2800 x 1310              | 10011330440 |
| Rubna traka / narudžba: tm      |             |
| Kod                             | 34617       |

## Natural Nebraska Oak H3331 ST10

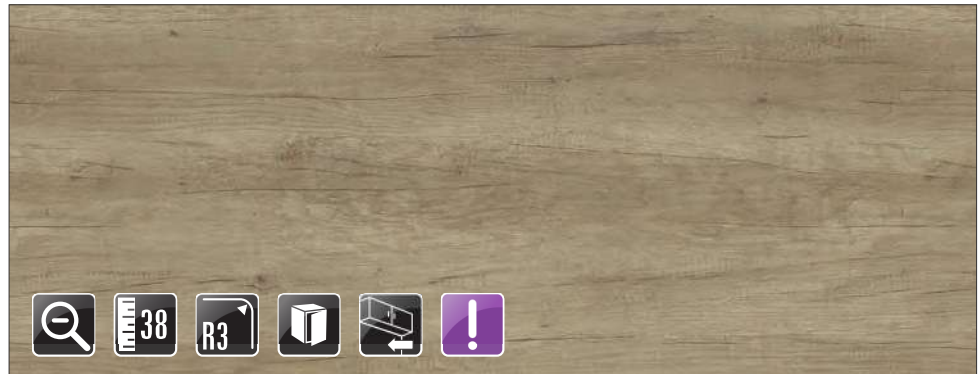
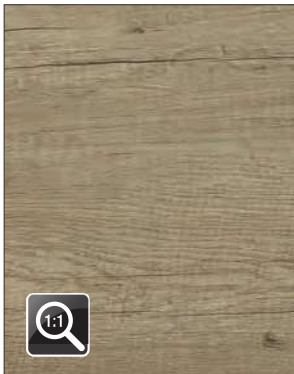

| Radna ploča (mm)     |             |
|----------------------|-------------|
| 38/R3 x 600 x 4100   | 10012554400 |
| 38/R3 x 1200 x 4100  | 10012554860 |
| Ploča stola (mm)     |             |
| 38/2*R3 x 920 x 4100 | 10001910360 |
| Iveral (mm)          |             |
| 18 x 2070 x 2800     | 20023331180 |

| Kuhinjska zidna obloga (mm)  |             |
|------------------------------|-------------|
| 8 x 640 x 4100               | 10012590110 |
| Kutna letva / setovi kutnika |             |
| Trokutastog presjeka         | 10015801670 |
| tip 56                       | 10015710240 |

| Laminat (mm)                    |             |
|---------------------------------|-------------|
| Traka, s ljepljom:<br>5000 x 45 | 10005020260 |
| Ploča: 2800 x 1310              | 10011330430 |
| Rubna traka / narudžba: tm      |             |
| Kod                             | 34613       |

## Grey Nebraska Oak H3332 ST10

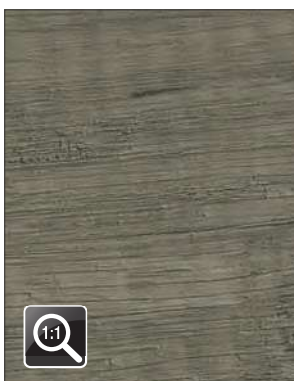

| Radna ploča (mm)     |             |
|----------------------|-------------|
| 38/R3 x 600 x 4100   | 10012554510 |
| Ploča stola (mm)     |             |
| 38/2*R3 x 920 x 4100 | 10001910370 |

| Kutna letva / setovi kutnika |             |
|------------------------------|-------------|
| Trokutastog presjeka         | 10015801725 |
| tip 56                       | 10015710220 |

| Laminat (mm)                    |             |
|---------------------------------|-------------|
| Traka, s ljepljom:<br>5000 x 45 | 10005020370 |
| Ploča: 2800 x 1310              | 10011330540 |
| Rubna traka / narudžba: tm      |             |
| Kod                             | 34785       |



## Grey Arizona Oak H1150 ST10



| Radna ploča (mm)   |             |
|--------------------|-------------|
| 38/R3 x 600 x 4100 | 10012554520 |

| Kutna letva / setovi kutnika |             |
|------------------------------|-------------|
| Trokutastog presjeka         | 10015801730 |
| tip 56                       | 10015710220 |

| Laminat (mm)                    |             |
|---------------------------------|-------------|
| Traka, s ljepljom:<br>5000 x 45 | 10005020380 |
| Ploča: 2800 x 1310              | 10011330550 |
| Rubna traka / narudžba: tm      |             |
| Kod                             | 34783       |

## Brown Arizona Oak H1151 ST10



| Radna ploča (mm)     |             |
|----------------------|-------------|
| 38/R3 x 600 x 4100   | 10012554530 |
| Ploča stola (mm)     |             |
| 38/2*R3 x 920 x 4100 | 10001910420 |
| Iveral (mm)          |             |
| 18 x 2070 x 2800     | 20021151180 |

| Kutna letva / setovi kutnika |             |
|------------------------------|-------------|
| Trokutastog presjeka         | 10015801735 |
| tip 56                       | 10015710250 |

| Laminat (mm)                    |             |
|---------------------------------|-------------|
| Traka, s ljepljom:<br>5000 x 45 | 10005020390 |
| Ploča: 2800 x 1310              | 10011330560 |
| Rubna traka / narudžba: tm      |             |
| Kod                             | 34765       |

## Natural Anthor Oak H3330 ST36

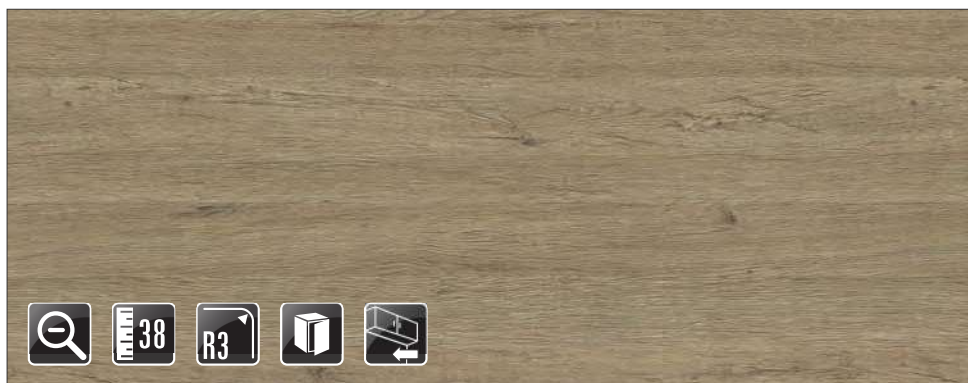
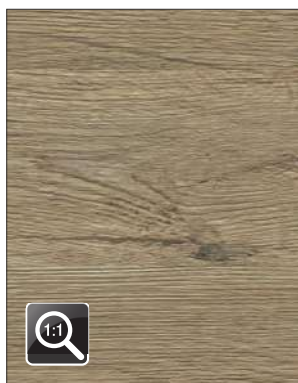

| Radna ploča (mm)   |             |
|--------------------|-------------|
| 38/R3 x 600 x 4100 | 10012553640 |
| Iveral (mm)        |             |
| 18 x 2070 x 2800   | 20023330180 |

| Kuhinjska zidna obloga (mm)  |             |
|------------------------------|-------------|
| 8 x 640 x 4100               | 10012590210 |
| Kutna letva / setovi kutnika |             |
| Trokutastog presjeka         | 10015802385 |
| tip 56                       | 10015710240 |

| Laminat (mm)               |             |
|----------------------------|-------------|
| Ploča: 2800 x 1310         | 10011331240 |
| Rubna traka / narudžba: tm |             |
| Kod                        | 34713       |

## Light Hunton Oak H2032 ST10

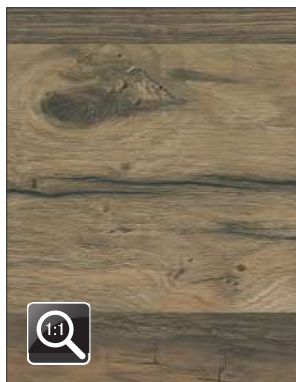

| Radna ploča (mm)   |             |
|--------------------|-------------|
| 38/R3 x 600 x 4100 | 10012553450 |
| Ploča stola (mm)   |             |
| 38/R3 x 920 x 4100 | 10001910510 |

| Kuhinjska zidna obloga (mm)  |             |
|------------------------------|-------------|
| 8 x 640 x 4100               | 10012590080 |
| Kutna letva / setovi kutnika |             |
| Trokutastog presjeka tip 56  | 10015802150 |
|                              | 10015710260 |

| Laminat (mm)                |             |
|-----------------------------|-------------|
| Traka, s ljeplom: 5000 x 45 | 10005020860 |
| Ploča: 2800 x 1310          | 10011331050 |
| Rubna traka / narudžba: tm  |             |
| Kod                         | 34766       |

## Dark Hunton Oak H2033 ST10

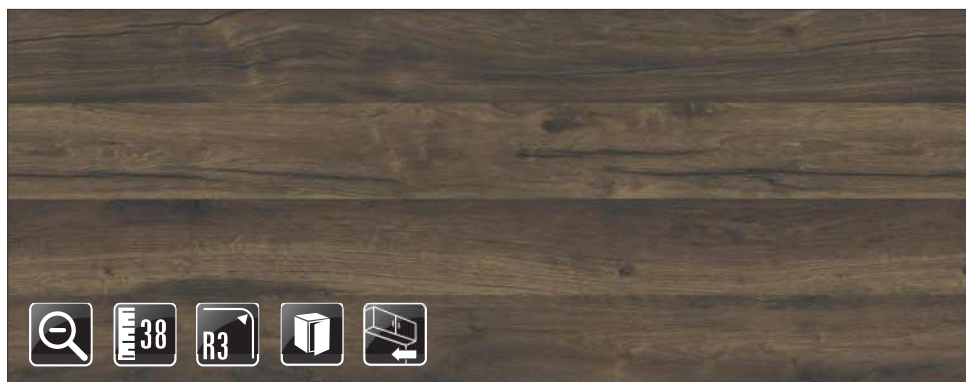
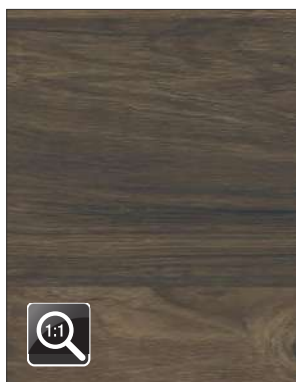

| Radna ploča (mm)   |             |
|--------------------|-------------|
| 38/R3 x 600 x 4100 | 10012553460 |
| Ploča stola (mm)   |             |
| 38/R3 x 920 x 4100 | 10001910520 |
| Iveral (mm)        |             |
| 18 x 2070 x 2800   | 20022033180 |

| Kuhinjska zidna obloga (mm)  |             |
|------------------------------|-------------|
| 8 x 640 x 4100               | 10012590080 |
| Kutna letva / setovi kutnika |             |
| Trokutastog presjeka tip 56  | 10015802155 |
|                              | 10015710260 |

| Laminat (mm)                |             |
|-----------------------------|-------------|
| Traka, s ljeplom: 5000 x 45 | 10005020870 |
| Ploča: 2800 x 1310          | 10011331060 |
| Rubna traka / narudžba: tm  |             |
| Kod                         | 34767       |

## Natural Vintage Wood H197 ST10

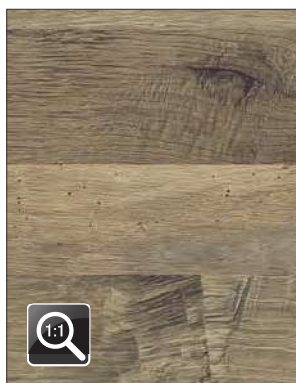

| Radna ploča (mm)   |             |
|--------------------|-------------|
| 38/R3 x 600 x 4100 | 10012553600 |

| Kutna letva / setovi kutnika |             |
|------------------------------|-------------|
| Trokutastog presjeka tip 56  | 10015802365 |
|                              | 10015710220 |

| Laminat (mm)               |             |
|----------------------------|-------------|
| Ploča: 2800 x 1310         | 10011331200 |
| Rubna traka / narudžba: tm |             |
| Kod                        | 35730       |

## Grey Vintage Wood H198 ST10



| Radna ploča (mm)   |             |
|--------------------|-------------|
| 38/R3 x 600 x 4100 | 10012553610 |

| Kutna letva / setovi kutnika |             |
|------------------------------|-------------|
| Trokutastog presjeka         | 10015802370 |
| tip 56                       | 10015710230 |

| Laminat (mm)               |             |
|----------------------------|-------------|
| Ploča: 2800 x 1310         | 10011331210 |
| Rubna traka / narudžba: tm |             |
| Kod                        | 35731       |

## Grey Brown Whiteriver Oak H1313 ST10



| Radna ploča (mm)   |             |
|--------------------|-------------|
| 38/R3 x 600 x 4100 | 10012553620 |
| Iveral (mm)        |             |
| 18 x 2070 x 2800   | 20021313180 |

| Kutna letva / setovi kutnika |             |
|------------------------------|-------------|
| Trokutastog presjeka         | 10015802375 |
| tip 56                       | 10015710230 |

| Laminat (mm)               |             |
|----------------------------|-------------|
| Ploča: 2800 x 1310         | 10011331220 |
| Rubna traka / narudžba: tm |             |
| Kod                        | 34633       |

## Truffle Brown Davos Oak H3133 ST12

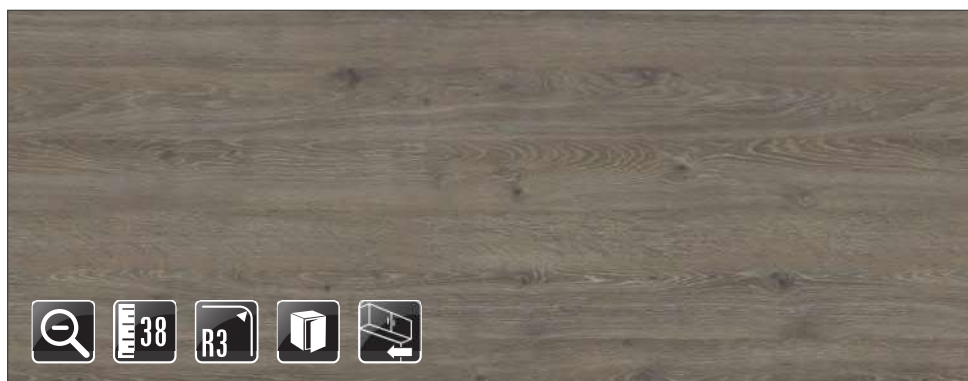
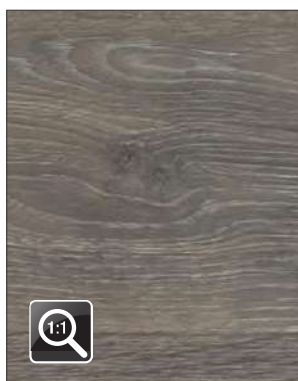

| Radna ploča (mm)     |             |
|----------------------|-------------|
| 38/R3 x 600 x 4100   | 10012553310 |
| Ploča stola (mm)     |             |
| 38/2*R3 x 920 x 4100 | 10001910430 |
| Iveral (mm)          |             |
| 18 x 2070 x 2800     | 20023133180 |

| Kuhinjska zidna obloga (mm)  |             |
|------------------------------|-------------|
| 8 x 640 x 4100               | 10012590090 |
| Kutna letva / setovi kutnika |             |
| Trokutastog presjeka         | 10015802050 |
| tip 56                       | 10015710250 |

| Laminat (mm)                    |             |
|---------------------------------|-------------|
| Traka, s ljepljom:<br>5000 x 45 | 10005020730 |
| Ploča: 2800 x 1310              | 10011330890 |
| Rubna traka / narudžba: tm      |             |
| Kod                             | 34656       |



## Black Halford Oak H2031 ST10



| Radna ploča (mm)            |             |
|-----------------------------|-------------|
| 38/R3 x 600 x 4100          | 10012553440 |
| Kuhinjska zidna obloga (mm) |             |
| 8 x 640 x 4100              | 10012590070 |

| Kutna letva / setovi kutnika |             |
|------------------------------|-------------|
| Trokutastog presjeka         | 10015802145 |
| tip 56                       | 10015710260 |

| Laminat (mm)                    |             |
|---------------------------------|-------------|
| Traka, s ljepljom:<br>5000 x 45 | 10005020850 |
| Ploča: 2800 x 1310              | 10011331040 |
| Rubna traka / narudžba: tm      |             |
| Kod                             | 34800       |

## Black-Brown Sorano Oak H1137 ST12

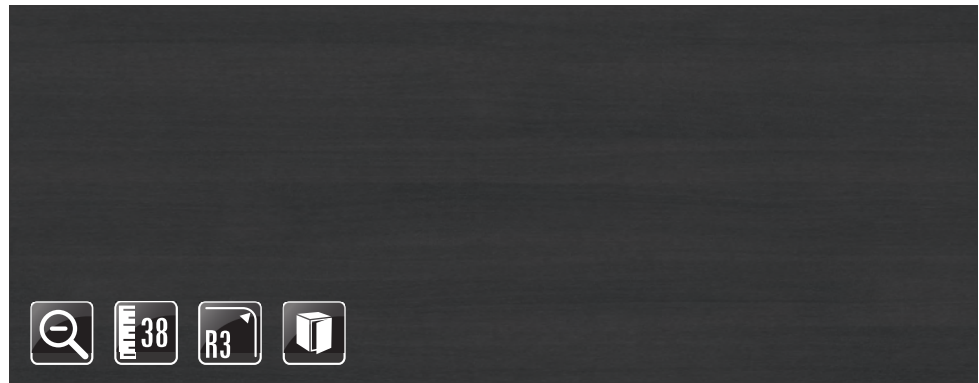
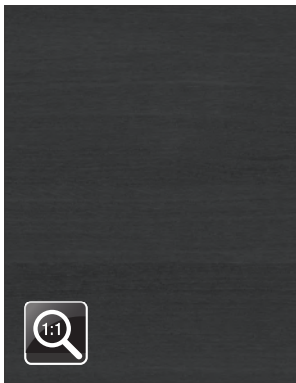

| Radna ploča (mm)   |             |
|--------------------|-------------|
| 38/R3 x 600 x 4100 | 10012554470 |
| Iveral (mm)        |             |
| 18 x 2070 x 2800   | 20021137181 |

| Kutna letva / setovi kutnika |             |
|------------------------------|-------------|
| Trokutastog presjeka         | 10015801705 |
| tip 56                       | 10015710260 |

| Laminat (mm)                    |             |
|---------------------------------|-------------|
| Traka, s ljepljom:<br>5000 x 45 | 10005020330 |
| Ploča: 2800 x 1310              | 10011330500 |
| Rubna traka / narudžba: tm      |             |
| Kod                             | 34830       |

## Castle Oak H195 ST10

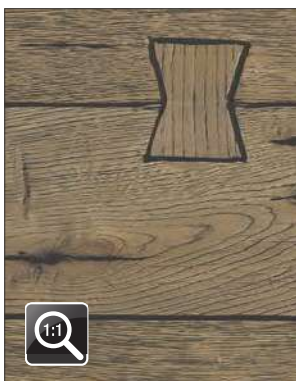

| Radna ploča / Ploča stola (mm) |             |
|--------------------------------|-------------|
| 38/R3 x 600 x 4100             | 10012553590 |

| Kutna letva / setovi kutnika |             |
|------------------------------|-------------|
| Trokutastog presjeka         | 10015802360 |
| tip 56                       | 10015710240 |

| Laminat (mm)               |             |
|----------------------------|-------------|
| Ploča: 2800 x 1310         | 10011331190 |
| Rubna traka / narudžba: tm |             |
| Kod                        | 34786       |

## Natural Woodblocks H050 ST9

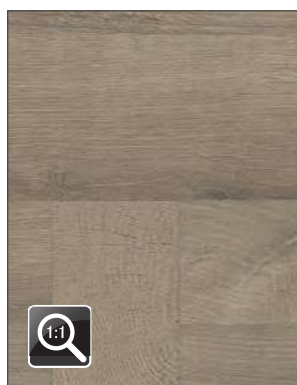

| Radna ploča (mm)            |             |
|-----------------------------|-------------|
| 38/R3 x 600 x 4100          | 10012553410 |
| Kuhinjska zidna obloga (mm) |             |
| 8 x 640 x 4100              | 10012590200 |

| Kutna letva / setovi kutnika |             |
|------------------------------|-------------|
| Trokutastog presjeka         | 10015802135 |
| tip 56                       | 10015710240 |

| Laminat (mm)                    |             |
|---------------------------------|-------------|
| Traka, s ljepljom:<br>5000 x 45 | 10005020830 |
| Ploča: 2800 x 1310              | 10011331010 |
| Rubna traka / narudžba: tm      |             |
| Kod                             | 35720       |

## Oak Butcherblock H193 ST12

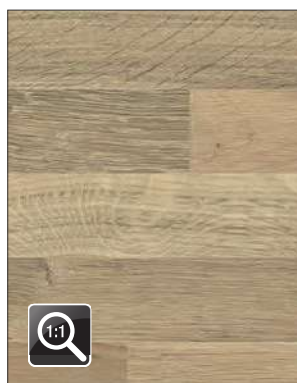

| Radna ploča (mm)   |             |
|--------------------|-------------|
| 38/R3 x 600 x 4100 | 10012553570 |

| Kutna letva / setovi kutnika |             |
|------------------------------|-------------|
| Trokutastog presjeka         | 10015802350 |
| tip 56                       | 10015710260 |

| Laminat (mm)               |             |
|----------------------------|-------------|
| Ploča: 2800 x 1310         | 10011331170 |
| Rubna traka / narudžba: tm |             |
| Kod                        | 34712       |

## Walnut Butcherblock H194 ST12

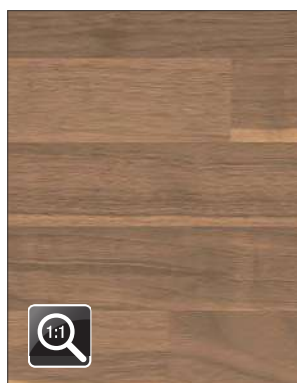

| Radna ploča (mm)   |             |
|--------------------|-------------|
| 38/R3 x 600 x 4100 | 10012553580 |

| Kutna letva / setovi kutnika |             |
|------------------------------|-------------|
| Trokutastog presjeka         | 10015802355 |
| tip 56                       | 10015710250 |

| Laminat (mm)               |             |
|----------------------------|-------------|
| Ploča: 2800 x 1310         | 10011331180 |
| Rubna traka / narudžba: tm |             |
| Kod                        | 35416       |

## Malawi Brown F905 ST22

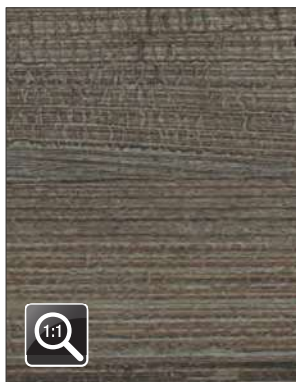

| Radna ploča (mm)     |             |
|----------------------|-------------|
| 38/R3 x 600 x 4100   | 10012554230 |
| Ploča stola (mm)     |             |
| 38/2*R3 x 920 x 4100 | 10001910230 |

| Kutna letva / setovi kutnika |             |
|------------------------------|-------------|
| Trokutastog presjeka         | 10015801320 |
| tip 56                       | 10015710220 |

| Laminat (mm)                    |             |
|---------------------------------|-------------|
| Traka, s ljepljom:<br>5000 x 45 | 10005020115 |
| Ploča: 2800 x 1310              | 10011330220 |

## Natural Pacific Walnut H3700 ST10

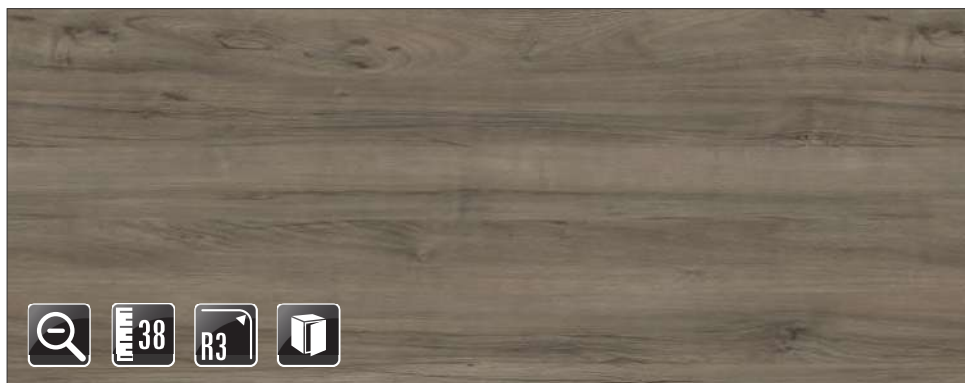
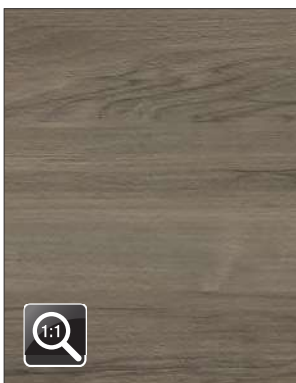

| Radna ploča (mm)   |             |
|--------------------|-------------|
| 38/R3 x 600 x 4100 | 10012554390 |
| Iveral (mm)        |             |
| 18 x 2070 x 2800   | 20023700180 |

| Kutna letva / setovi kutnika |             |
|------------------------------|-------------|
| Trokutastog presjeka         | 10015801665 |
| tip 56                       | 10015710240 |

| Laminat (mm)                    |             |
|---------------------------------|-------------|
| Traka, s ljepljom:<br>5000 x 45 | 10005020250 |
| Ploča: 2800 x 1310              | 10011330420 |
| Rubna traka / narudžba: tm      |             |
| Kod                             | 35900       |

## Tobacco Pacific Walnut H3702 ST10

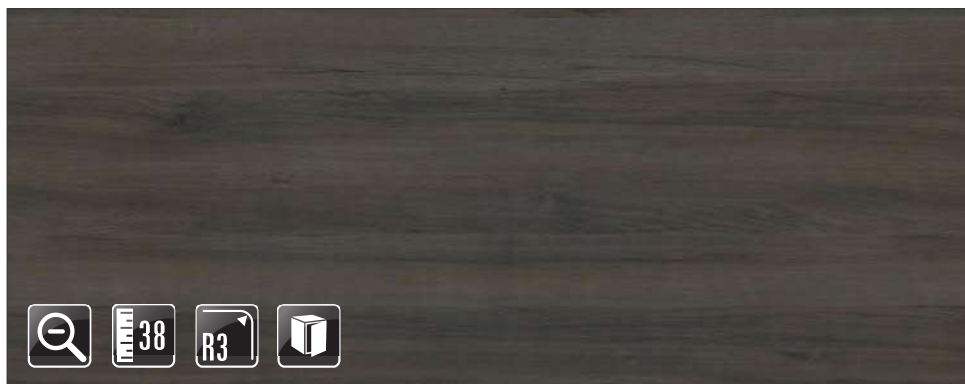

| Radna ploča (mm)     |             |
|----------------------|-------------|
| 38/R3 x 600 x 4100   | 10012553330 |
| Ploča stola (mm)     |             |
| 38/2*R3 x 920 x 4100 | 10001910450 |
| Iveral (mm)          |             |
| 18 x 2070 x 2800     | 20023702180 |

| Kutna letva / setovi kutnika |             |
|------------------------------|-------------|
| Trokutastog presjeka         | 10015802060 |
| tip 56                       | 10015710250 |

| Laminat (mm)                    |             |
|---------------------------------|-------------|
| Traka, s ljepljom:<br>5000 x 45 | 10005020750 |
| Ploča: 2800 x 1310              | 10011330910 |
| Rubna traka / narudžba: tm      |             |
| Kod                             | 35515       |



## Tobacco Aida Walnut H3704 ST15

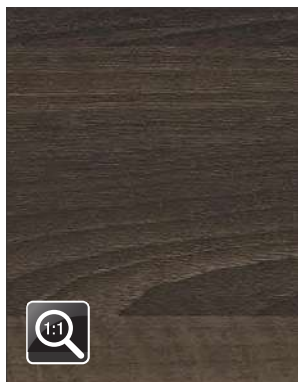

| Radna ploča (mm)     |             |
|----------------------|-------------|
| 38/R3 x 600 x 4100   | 10012553340 |
| Ploča stola (mm)     |             |
| 38/2*R3 x 920 x 4100 | 10001910440 |

| Kutna letva / setovi kutnika |             |
|------------------------------|-------------|
| Trokutastog presjeka         | 10015802065 |
| tip 56                       | 10015710250 |

| Laminat (mm)                   |             |
|--------------------------------|-------------|
| Traka, s ljeplom:<br>5000 x 45 | 10005020760 |
| Ploča: 2800 x 1310             | 10011330920 |
| Rubna traka / narudžba: tm     |             |
| Kod                            | 35480       |

## Sealand Pine H110 ST9

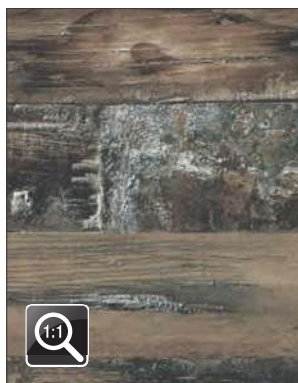

| Radna ploča (mm)            |             |
|-----------------------------|-------------|
| 38/R3 x 600 x 4100          | 10012553250 |
| Kuhinjska zidna obloga (mm) |             |
| 8 x 640 x 4100              | 10012590010 |

| Kutna letva / setovi kutnika |             |
|------------------------------|-------------|
| Trokutastog presjeka         | 10015802020 |
| tip 56                       | 10015710240 |

| Laminat (mm)                   |             |
|--------------------------------|-------------|
| Traka, s ljeplom:<br>5000 x 45 | 10005020670 |
| Ploča: 2800 x 1310             | 10011330830 |
| Rubna traka / narudžba: tm     |             |
| Kod                            | 35262       |

## Bramberg Pine H1487 ST22

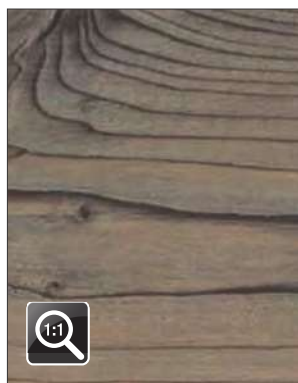

| Radna ploča (mm)     |             |
|----------------------|-------------|
| 38/R3 x 600 x 4100   | 10012554370 |
| Ploča stola (mm)     |             |
| 38/2*R3 x 920 x 4100 | 10001910460 |
| Iveral (mm)          |             |
| 18 x 2070 x 2800     | 20021487180 |

| Kutna letva / setovi kutnika |             |
|------------------------------|-------------|
| Trokutastog presjeka         | 10015801655 |
| tip 56                       | 10015710240 |

| Laminat (mm)                   |             |
|--------------------------------|-------------|
| Traka, s ljeplom:<br>5000 x 45 | 10005020230 |
| Ploča: 2800 x 1310             | 10011330400 |
| Rubna traka / narudžba: tm     |             |
| Kod                            | 35103       |

## Fineline Cream H1424 ST22

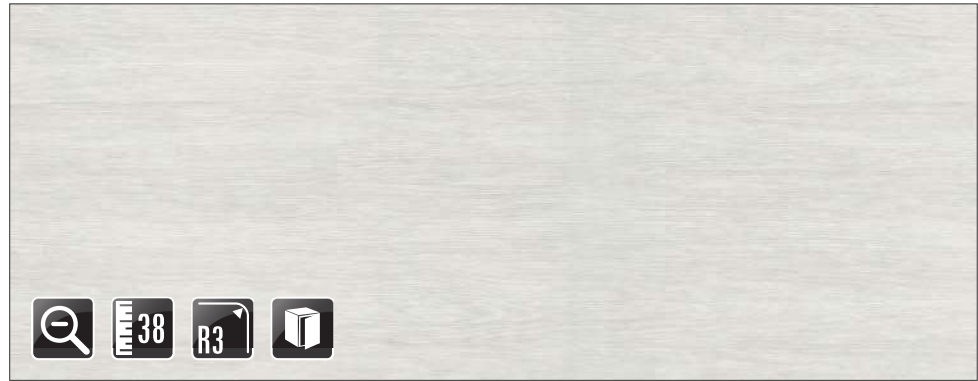

| Radna ploča (mm)     |             |
|----------------------|-------------|
| 38/R3 x 600 x 4100   | 10012554200 |
| Ploča stola (mm)     |             |
| 38/2*R3 x 920 x 4100 | 10001910160 |
| Iveral (mm)          |             |
| 18 x 2070 x 2800     | 20021424180 |

| Kutna letva / setovi kutnika |             |
|------------------------------|-------------|
| Trokutastog presjeka         | 10015801305 |
| tip 56                       | 10015710210 |

| Laminat (mm)                    |             |
|---------------------------------|-------------|
| Traka, s ljepljom:<br>5000 x 45 | 10005020100 |
| Ploča: 2800 x 1310              | 10011330260 |
| Rubna traka / narudžba: tm      |             |
| Kod                             | 36210       |

## Cascina Pine H1401 ST22



| Radna ploča (mm)            |             |
|-----------------------------|-------------|
| 38/R3 x 600 x 4100          | 10012553290 |
| Iveral (mm)                 |             |
| 18 x 2070 x 2800            | 20021401180 |
| Kuhinjska zidna obloga (mm) |             |
| 8 x 640 x 4100              | 10012590060 |

| Kutna letva / setovi kutnika |             |
|------------------------------|-------------|
| Trokutastog presjeka         | 10015802040 |
| tip 56                       | 10015710220 |

| Laminat (mm)                    |             |
|---------------------------------|-------------|
| Traka, s ljepljom:<br>5000 x 45 | 10005020710 |
| Ploča: 2800 x 1310              | 10011330860 |
| Rubna traka / narudžba: tm      |             |
| Kod                             | 35114       |

## Pasadena Pine H1486 ST36



| Radna ploča (mm)            |             |
|-----------------------------|-------------|
| 38/R3 x 600 x 4100          | 10012553430 |
| Iveral (mm)                 |             |
| 18 x 2070 x 2800            | 20021486180 |
| Kuhinjska zidna obloga (mm) |             |
| 8 x 640 x 4100              | 10012590050 |

| Kutna letva / setovi kutnika |             |
|------------------------------|-------------|
| Trokutastog presjeka         | 10015802140 |
| tip 56                       | 10015710220 |

| Laminat (mm)                    |             |
|---------------------------------|-------------|
| Traka, s ljepljom:<br>5000 x 45 | 10005020840 |
| Ploča: 2800 x 1310              | 10011331030 |
| Rubna traka / narudžba: tm      |             |
| Kod                             | 35250       |



H1401 / U702 / U727

## Mainau Birch H1733 ST9

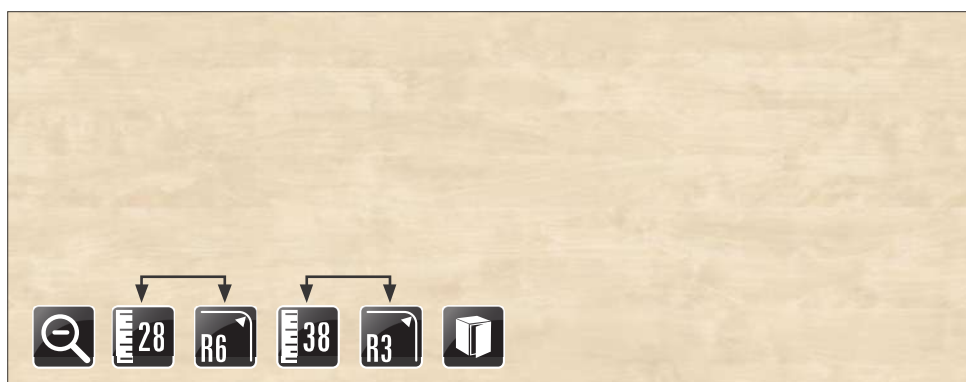
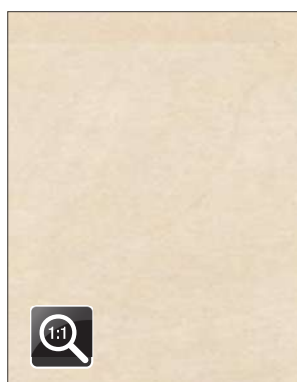

| Radna ploča (mm)     |             |
|----------------------|-------------|
| 28/R6 x 600 x 4100   | 10012551640 |
| 38/R3 x 600 x 4100   | 10012554070 |
| Ploča stola (mm)     |             |
| 38/2*R3 x 920 x 4100 | 10001910180 |

| Iveral (mm)                  |             |
|------------------------------|-------------|
| 18 x 2070 x 2800             | 20021733180 |
| Kutna letva / setovi kutnika |             |
| Trokutastog presjeka         | 10015801120 |
| tip 56                       | 10015710230 |

| Laminat (mm)                    |             |
|---------------------------------|-------------|
| Traka, s ljepljom:<br>5000 x 32 | 10005003240 |
| Traka, s ljepljom:<br>5000 x 45 | 10005020035 |
| Ploča: 2800 x 1310              | 10011330020 |
| Rubna traka / narudžba: tm      |             |
| Kod                             | 33795       |



## Light Lakeland Acacia H1277 ST9



| Radna ploča (mm)     |             |
|----------------------|-------------|
| 38/R3 x 600 x 4100   | 10012554170 |
| Ploča stola (mm)     |             |
| 38/2*R3 x 920 x 4100 | 10001910210 |

| Iveral (mm)                  |             |
|------------------------------|-------------|
| 18 x 2070 x 2800             | 20021277180 |
| Kutna letva / setovi kutnika |             |
| Trokutastog presjeka tip 56  | 10015801290 |
|                              | 10015710220 |

| Laminat (mm)                 |             |
|------------------------------|-------------|
| Traka, s ljepljom: 5000 x 45 | 10005020085 |
| Ploča: 2800 x 1310           | 10011330250 |
| Rubna traka / narudžba: tm   |             |
| Kod                          | 34580       |

## Coco Bolo H3012 ST22



| Radna ploča (mm)     |             |
|----------------------|-------------|
| 38/R3 x 600 x 4100   | 10012554450 |
| Ploča stola (mm)     |             |
| 38/2*R3 x 920 x 4100 | 10001910350 |

| Iveral (mm)                  |             |
|------------------------------|-------------|
| 18 x 2070 x 2800             | 20023012180 |
| Kutna letva / setovi kutnika |             |
| Trokutastog presjeka tip 56  | 10015801695 |
|                              | 10015710220 |

| Laminat (mm)                 |             |
|------------------------------|-------------|
| Traka, s ljepljom: 5000 x 45 | 10005020310 |
| Ploča: 2800 x 1310           | 10011330480 |
| Rubna traka / narudžba: tm   |             |
| Kod                          | 35895       |

## Mali Wenge H3058 ST22



| Radna ploča (mm)   |             |
|--------------------|-------------|
| 38/R3 x 600 x 4100 | 10012554430 |
| Iveral (mm)        |             |
| 18 x 2070 x 2800   | 20023058180 |

| Kutna letva / setovi kutnika |             |
|------------------------------|-------------|
| Trokutastog presjeka tip 56  | 10015801685 |
|                              | 10015710260 |

| Laminat (mm)                 |             |
|------------------------------|-------------|
| Traka, s ljepljom: 5000 x 45 | 10005020290 |
| Ploča: 2800 x 1310           | 10011330460 |
| Rubna traka / narudžba: tm   |             |
| Kod                          | 36180       |

## Argento 2608 Lucido

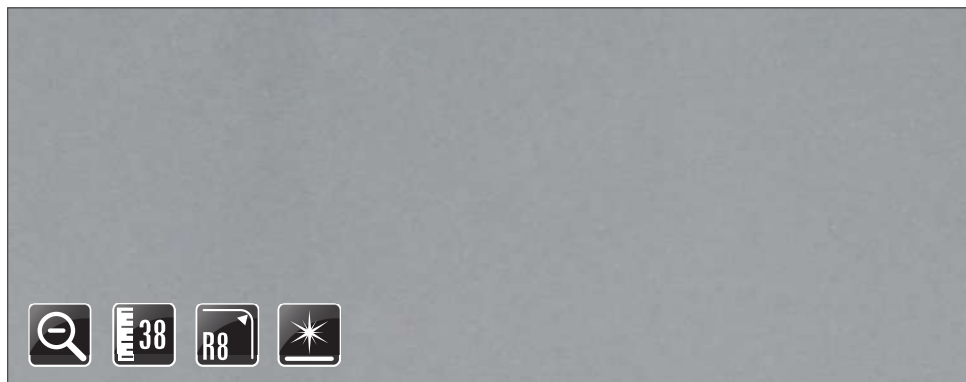
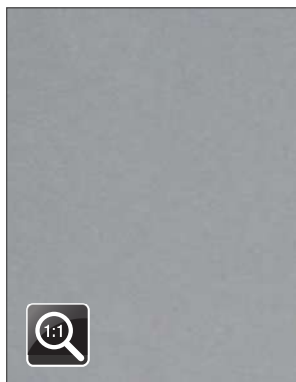

| Radna ploča (mm)   |             |
|--------------------|-------------|
| 38/R8 x 600 x 4200 | 10012506450 |

| Kutna letva / setovi kutnika |             |
|------------------------------|-------------|
| Trokutastog presjeka         | 10015801885 |
| tip 56                       | 10015710230 |

| Laminat (mm)       |             |
|--------------------|-------------|
| Traka: 4200 x 45   | 10004807250 |
| Ploča: 4200 x 1305 | 10011306620 |

## Bruno Gazzella 576 Lucido

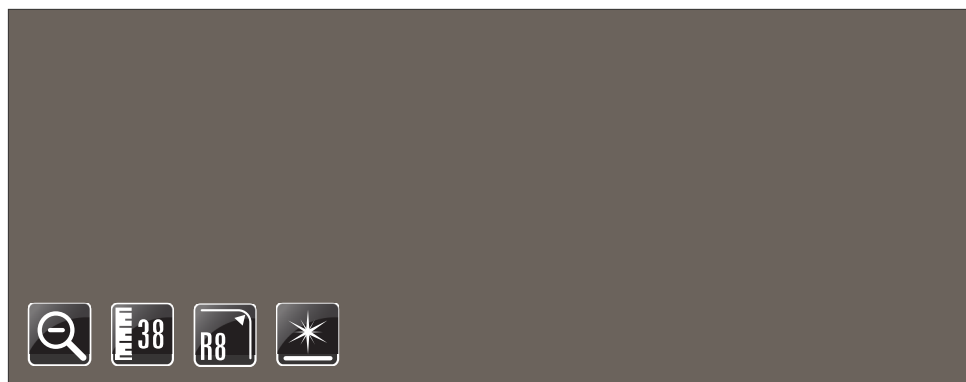
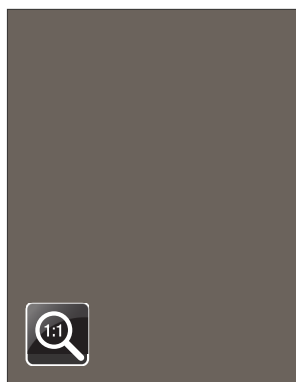

| Radna ploča (mm)   |             |
|--------------------|-------------|
| 38/R8 x 600 x 4200 | 10012506440 |

| Kutna letva / setovi kutnika |             |
|------------------------------|-------------|
| Trokutastog presjeka         | 10015801880 |
| tip 56                       | 10015710250 |

| Laminat (mm)       |             |
|--------------------|-------------|
| Traka: 4200 x 45   | 10004807240 |
| Ploča: 4200 x 1305 | 10011306610 |

## 1188 Velvet

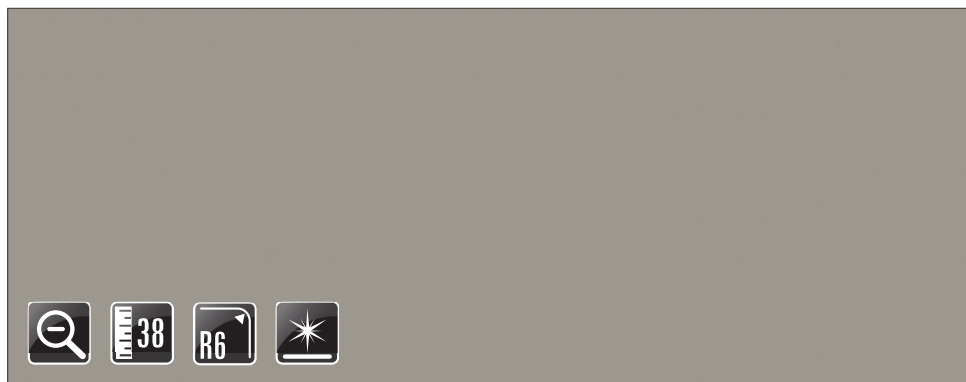
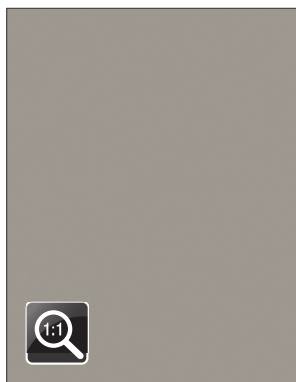

| Radna ploča (mm)   |             |
|--------------------|-------------|
| 38/R6 x 600 x 4200 | 10012506820 |

| Kutna letva / setovi kutnika |             |
|------------------------------|-------------|
| Trokutastog presjeka         | 10015802235 |
| tip 56                       | 10015710230 |

| Laminat (mm)       |             |
|--------------------|-------------|
| Traka: 2090 x 42   | 10004807620 |
| Ploča: 4200 x 1300 | 10011306990 |

## 1189 Velvet

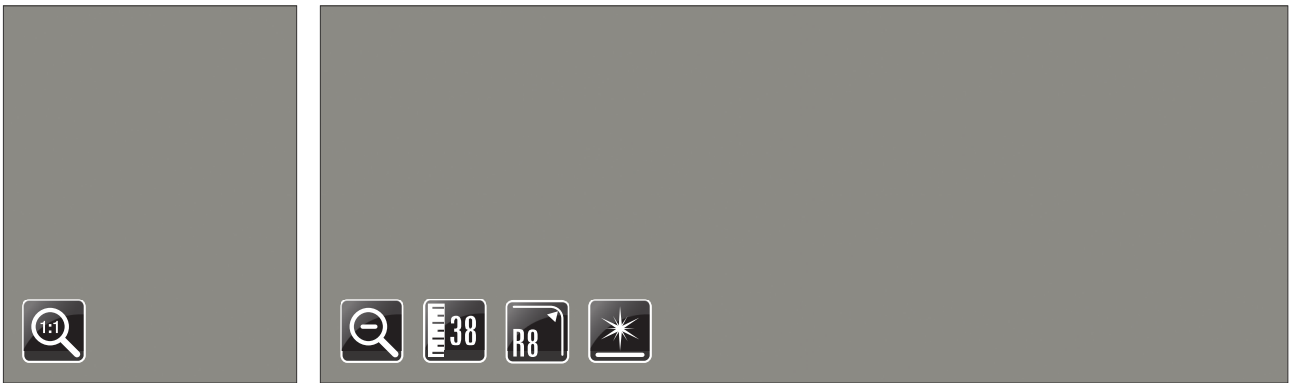

| Radna ploča (mm)   |             |
|--------------------|-------------|
| 38/R8 x 600 x 4200 | 10012506830 |

| Kutna letva / setovi kutnika |             |
|------------------------------|-------------|
| Trokutastog presjeka         | 10015802240 |
| tip 56                       | 10015710230 |

| Laminat (mm)       |             |
|--------------------|-------------|
| Traka: 2090 x 42   | 10004807630 |
| Ploča: 4200 x 1300 | 10011307000 |

## Grigio 5058 Lucido



| Radna ploča (mm)   |             |
|--------------------|-------------|
| 38/R8 x 600 x 4200 | 10012506460 |

| Kutna letva / setovi kutnika |             |
|------------------------------|-------------|
| Trokutastog presjeka         | 10015801890 |
| tip 56                       | 10015710260 |

| Laminat (mm)       |             |
|--------------------|-------------|
| Traka: 4200 x 45   | 10004807260 |
| Ploča: 4200 x 1305 | 10011306630 |

## Glossy 5547 Lucido

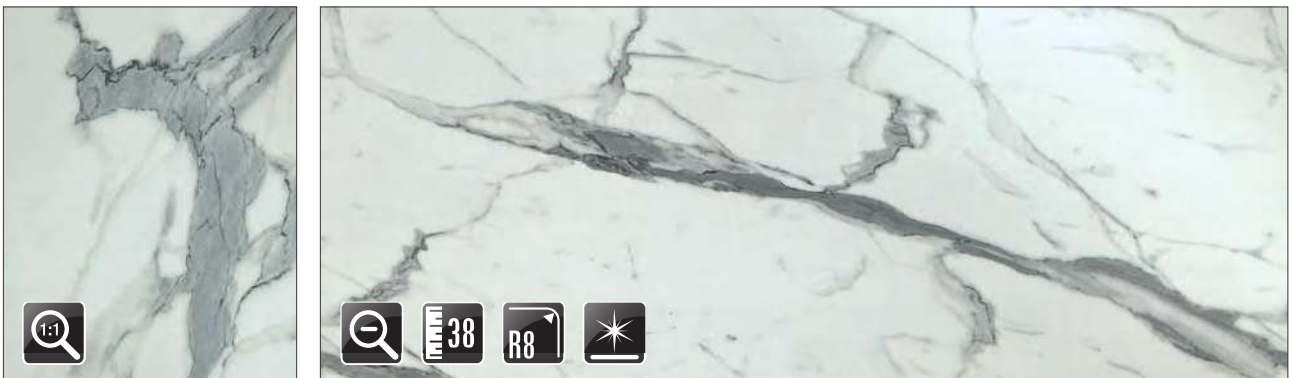

| Radna ploča (mm)   |             |
|--------------------|-------------|
| 38/R8 x 600 x 4200 | 10012506670 |

| Kutna letva / setovi kutnika |             |
|------------------------------|-------------|
| Trokutastog presjeka         | 10015802125 |
| tip 56                       | 10015710210 |

| Laminat (mm)       |             |
|--------------------|-------------|
| Traka: 4200 x 45   | 10004807470 |
| Ploča: 4200 x 1300 | 10011306840 |



## Thala 6085 Shiky

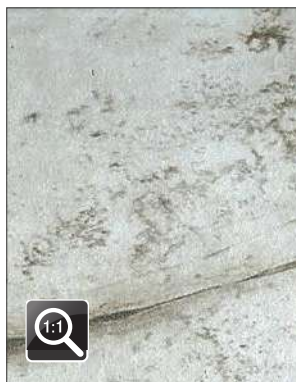

| Radna ploča (mm)   |             |
|--------------------|-------------|
| 38/R6 x 600 x 4200 | 10012506760 |

| Kutna letva / setovi kutnika |             |
|------------------------------|-------------|
| Trokutastog presjeka         | 10015802205 |
| tip 56                       | 10015710210 |

| Laminat (mm)       |             |
|--------------------|-------------|
| Traka: 2090 x 42   | 10004807560 |
| Ploča: 4200 x 1300 | 10011306930 |

## 5707 Glossy

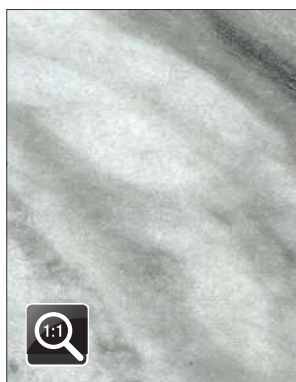

| Radna ploča (mm)     |             |
|----------------------|-------------|
| 38/R6 x 600 x 4200   | 10012506840 |
| Ploča stola (mm)     |             |
| 38/2*R6 x 900 x 4200 | 10001920190 |

| Kutna letva / setovi kutnika |             |
|------------------------------|-------------|
| Trokutastog presjeka         | 10015802245 |
| tip 56                       | 10015710230 |

| Laminat (mm)       |             |
|--------------------|-------------|
| Traka: 2090 x 42   | 10004807640 |
| Ploča: 4200 x 1400 | 10011307010 |

## 5707 Italian Stone



| Radna ploča (mm)   |             |
|--------------------|-------------|
| 38/R6 x 600 x 4200 | 10012506850 |

| Kutna letva / setovi kutnika |             |
|------------------------------|-------------|
| Trokutastog presjeka         | 10015802250 |
| tip 56                       | 10015710230 |

| Laminat (mm)       |             |
|--------------------|-------------|
| Traka: 2090 x 42   | 10004807650 |
| Ploča: 4200 x 1400 | 10011307020 |

## Cheope Touch 6080

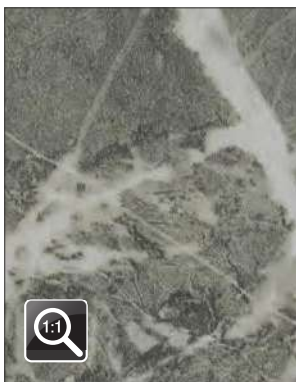

| Radna ploča (mm)   |             |
|--------------------|-------------|
| 38/R6 x 600 x 4200 | 10012506800 |

| Kutna letva / setovi kutnika |             |
|------------------------------|-------------|
| Trokutastog presjeka         | 10015802225 |
| tip 56                       | 10015710230 |

| Laminat (mm)       |             |
|--------------------|-------------|
| Traka: 2090 x 42   | 10004807600 |
| Ploča: 4200 x 1300 | 10011306970 |

## Alicante Papier 1457

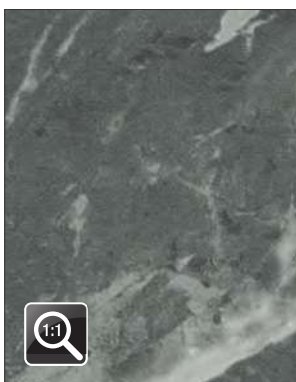

| Radna ploča (mm)   |             |
|--------------------|-------------|
| 38/R6 x 600 x 4200 | 10012506790 |

| Kutna letva / setovi kutnika |             |
|------------------------------|-------------|
| Trokutastog presjeka         | 10015802220 |
| tip 56                       | 10015710230 |

| Laminat (mm)       |             |
|--------------------|-------------|
| Traka: 2090 x 42   | 10004807590 |
| Ploča: 4200 x 1300 | 10011306960 |

## 5716 Glossy



| Radna ploča (mm)     |             |
|----------------------|-------------|
| 38/R6 x 600 x 4200   | 10012506860 |
| Ploča stola (mm)     |             |
| 38/2*R6 x 900 x 4200 | 10001920200 |

| Kutna letva / setovi kutnika |             |
|------------------------------|-------------|
| Trokutastog presjeka         | 10015802255 |
| tip 56                       | 10015710230 |

| Laminat (mm)       |             |
|--------------------|-------------|
| Traka: 2090 x 42   | 10004807660 |
| Ploča: 4200 x 1400 | 10011307030 |



## 5717 Glossy

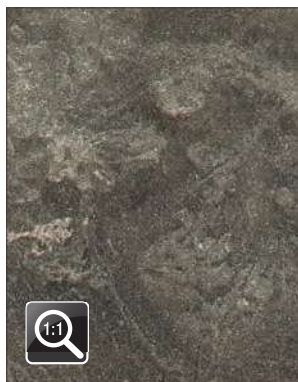

| Radna ploča (mm)     |             |
|----------------------|-------------|
| 38/R6 x 600 x 4200   | 10012506870 |
| Ploča stola (mm)     |             |
| 38/2*R6 x 900 x 4200 | 10001920180 |

| Kutna letva / setovi kutnika |             |
|------------------------------|-------------|
| Trokutastog presjeka         | 10015802260 |
| tip 56                       | 10015710230 |

| Laminat (mm)       |             |
|--------------------|-------------|
| Traka: 2090 x 42   | 10004807670 |
| Ploča: 4200 x 1400 | 10011307040 |

## Glossy 6072 Lucido

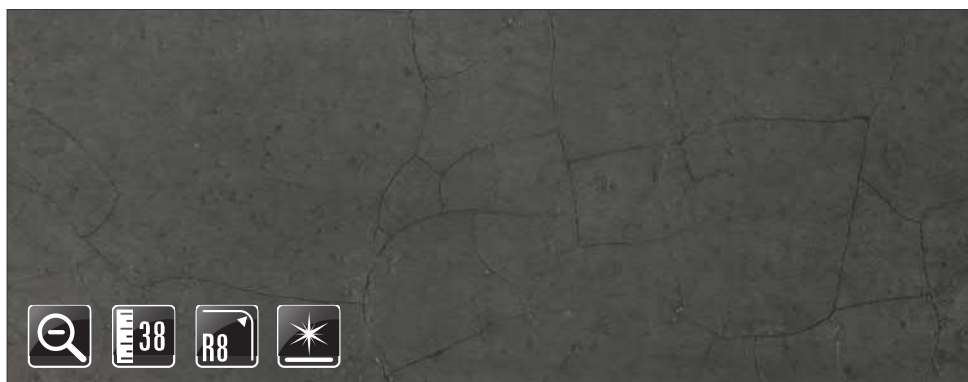
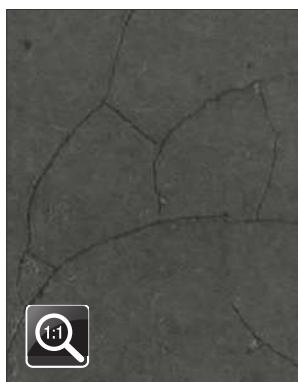

| Radna ploča (mm)   |             |
|--------------------|-------------|
| 38/R8 x 600 x 4200 | 10012506490 |

| Kutna letva / setovi kutnika |             |
|------------------------------|-------------|
| Trokutastog presjeka         | 10015801905 |
| tip 56                       | 10015710260 |

| Laminat (mm)       |             |
|--------------------|-------------|
| Traka: 4200 x 45   | 10004807290 |
| Ploča: 4200 x 1300 | 10011306660 |

## Glossy 5563 Lucido

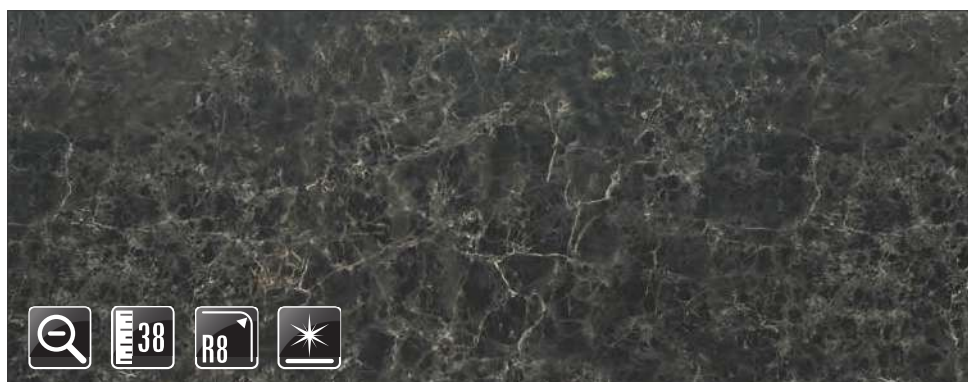
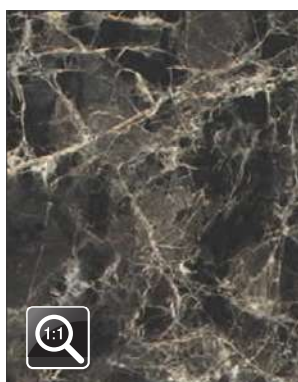

| Radna ploča (mm)   |             |
|--------------------|-------------|
| 38/R8 x 600 x 4200 | 10012506660 |

| Kutna letva / setovi kutnika |             |
|------------------------------|-------------|
| Trokutastog presjeka         | 10015802120 |
| tip 56                       | 10015710260 |

| Laminat (mm)       |             |
|--------------------|-------------|
| Traka: 4200 x 45   | 10004807460 |
| Ploča: 4200 x 1300 | 10011306830 |



## Glossy 5562 Lucido

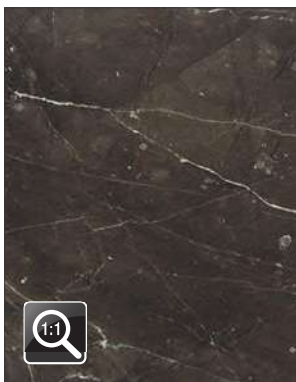

| Radna ploča (mm)   |             |
|--------------------|-------------|
| 38/R8 x 600 x 4200 | 10012506650 |

| Kutna letva / setovi kutnika |             |
|------------------------------|-------------|
| Trokutastog presjeka         | 10015802115 |
| tip 56                       | 10015710250 |

| Laminat (mm)       |             |
|--------------------|-------------|
| Traka: 4200 x 45   | 10004807450 |
| Ploča: 4200 x 1300 | 10011306820 |

## Toskana mramor 3498 60

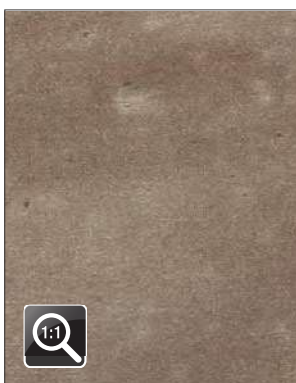

| Radna ploča (mm)   |             |
|--------------------|-------------|
| 38/R6 x 600 x 4200 | 10012506110 |

| Kutna letva / setovi kutnika |             |
|------------------------------|-------------|
| Trokutastog presjeka         | 10015801450 |
| tip 56                       | 10015710240 |

| Laminat (mm)       |             |
|--------------------|-------------|
| Traka: 2098 x 42   | 10004806890 |
| Ploča: 4200 x 1320 | 10011306290 |

## Glossy 5564 Lucido

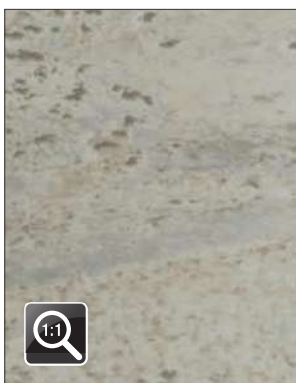

| Radna ploča (mm)   |             |
|--------------------|-------------|
| 38/R8 x 600 x 4200 | 10012506470 |

| Kutna letva / setovi kutnika |             |
|------------------------------|-------------|
| Trokutastog presjeka         | 10015801895 |
| tip 56                       | 10015710230 |

| Laminat (mm)       |             |
|--------------------|-------------|
| Traka: 4200 x 45   | 10004807270 |
| Ploča: 4200 x 1300 | 10011306640 |

## Glossy 5565 Lucido

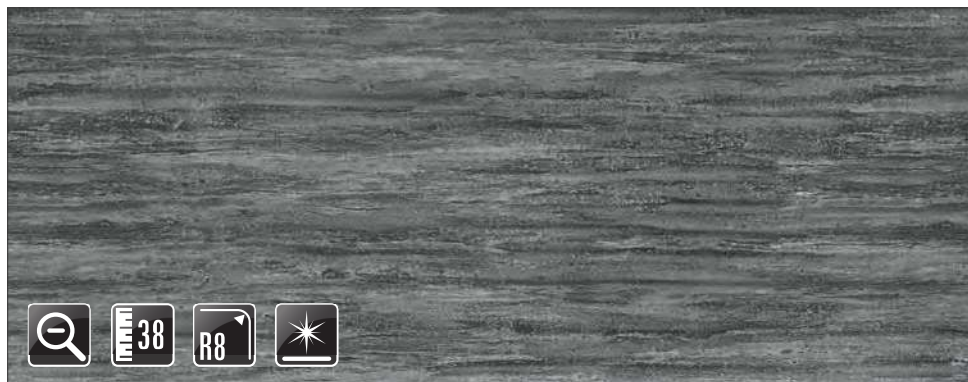
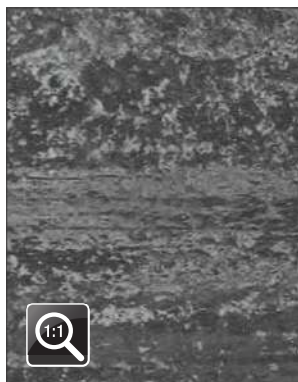

| Radna ploča (mm)   |             |
|--------------------|-------------|
| 38/R8 x 600 x 4200 | 10012506480 |

| Kutna letva / setovi kutnika |             |
|------------------------------|-------------|
| Trokutastog presjeka         | 10015801900 |
| tip 56                       | 10015710260 |

| Laminat (mm)       |             |
|--------------------|-------------|
| Traka: 4200 x 45   | 10004807280 |
| Ploča: 4200 x 1300 | 10011306650 |

## Mika 3331

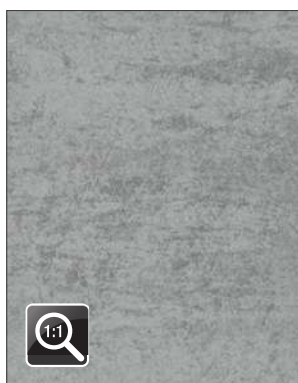

| Radna ploča (mm)   |             |
|--------------------|-------------|
| 38/R5 x 600 x 4200 | 10012506210 |

| Kutna letva / setovi kutnika |             |
|------------------------------|-------------|
| Trokutastog presjeka         | 10015801570 |
| tip 56                       | 10015710230 |

| Laminat (mm)       |             |
|--------------------|-------------|
| Traka: 2098 x 42   | 10004807020 |
| Ploča: 4200 x 1300 | 10011306390 |

## Wraky 6044

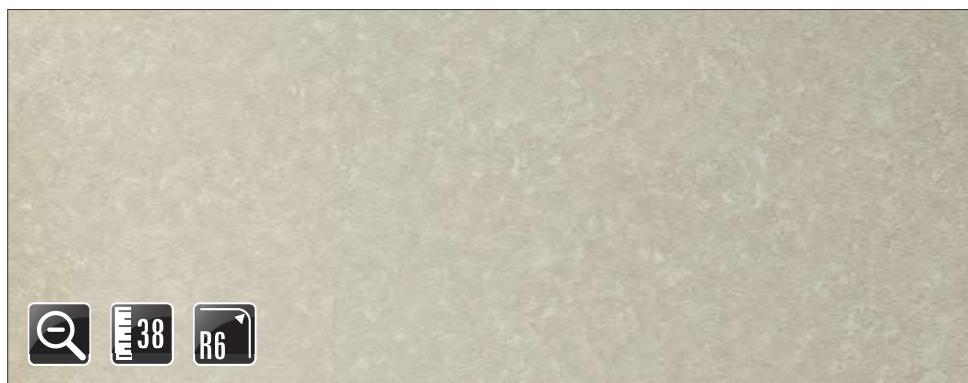
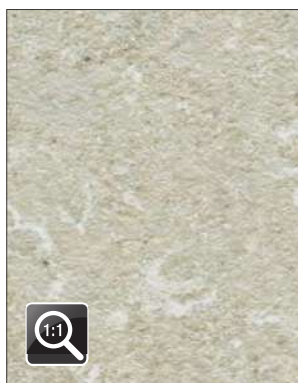

| Radna ploča (mm)   |             |
|--------------------|-------------|
| 38/R6 x 600 x 4200 | 10012506301 |

| Kutna letva / setovi kutnika |             |
|------------------------------|-------------|
| Trokutastog presjeka         | 10015801616 |
| tip 56                       | 10015710220 |

| Laminat (mm)       |             |
|--------------------|-------------|
| Traka: 2090 x 42   | 10004807111 |
| Ploča: 4200 x 1300 | 10011306485 |

## Cervino Mica M011

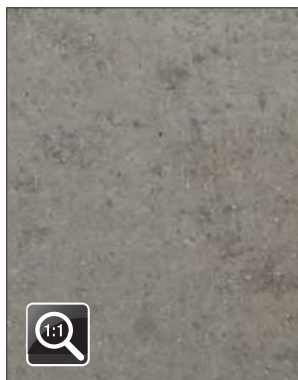

| Radna ploča (mm)   |             |
|--------------------|-------------|
| 38/R8 x 600 x 4200 | 10012506090 |

| Kutna letva / setovi kutnika |             |
|------------------------------|-------------|
| Trokutastog presjeka         | 10015801340 |
| tip 56                       | 10015710220 |

| Laminat (mm)       |             |
|--------------------|-------------|
| Traka: 2098 x 42   | 10004806870 |
| Ploča: 4200 x 1400 | 10011306270 |

## Vesuvio Mica M012

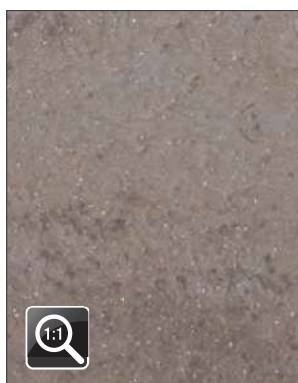

| Radna ploča (mm)   |             |
|--------------------|-------------|
| 38/R8 x 600 x 4200 | 10012506100 |

| Kutna letva / setovi kutnika |             |
|------------------------------|-------------|
| Trokutastog presjeka         | 10015801345 |
| tip 56                       | 10015710220 |

| Laminat (mm)       |             |
|--------------------|-------------|
| Traka: 2098 x 42   | 10004806880 |
| Ploča: 4200 x 1400 | 10011306280 |

## Mika 3325



| Radna ploča (mm)     |             |
|----------------------|-------------|
| 38/R5 x 600 x 4200   | 10012506220 |
| Ploča stola (mm)     |             |
| 38/2*R5 x 900 x 4200 | 10001920140 |

| Kutna letva / setovi kutnika |             |
|------------------------------|-------------|
| Trokutastog presjeka         | 10015801575 |
| tip 56                       | 10015710220 |

| Laminat (mm)       |             |
|--------------------|-------------|
| Traka: 2098 x 42   | 10004807030 |
| Ploča: 4200 x 1305 | 10011306400 |



## Mika 3326

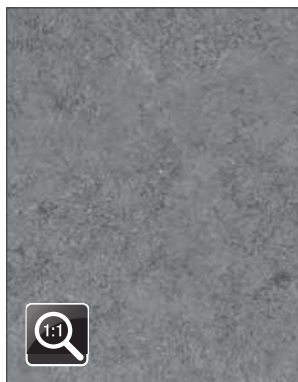

| Radna ploča (mm)   |             |
|--------------------|-------------|
| 38/R5 x 600 x 4200 | 10012506230 |

| Kutna letva / setovi kutnika |             |
|------------------------------|-------------|
| Trokutastog presjeka         | 10015801580 |
| tip 56                       | 10015710230 |

| Laminat (mm)       |             |
|--------------------|-------------|
| Traka: 2098 x 42   | 10004807040 |
| Ploča: 4200 x 1305 | 10011306410 |

## Mika 3329

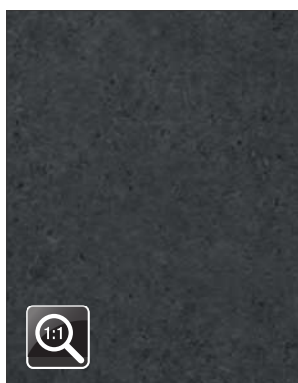

| Radna ploča (mm)   |             |
|--------------------|-------------|
| 38/R5 x 600 x 4200 | 10012506200 |
| Ploča stola (mm)   |             |
| 38/R5 x 900 x 4200 | 10001920106 |

| Kutna letva / setovi kutnika |             |
|------------------------------|-------------|
| Trokutastog presjeka         | 10015801565 |
| tip 56                       | 10015710260 |

| Laminat (mm)       |             |
|--------------------|-------------|
| Traka: 2098 x 42   | 10004807010 |
| Ploča: 4200 x 1305 | 10011306380 |

## 3413 Urban



| Radna ploča (mm)   |             |
|--------------------|-------------|
| 38/R6 x 600 x 4200 | 10012506770 |

| Kutna letva / setovi kutnika |             |
|------------------------------|-------------|
| Trokutastog presjeka         | 10015802210 |
| tip 56                       | 10015710230 |

| Laminat (mm)       |             |
|--------------------|-------------|
| Traka: 2090 x 42   | 10004807570 |
| Ploča: 4200 x 1300 | 10011306940 |

## 5027 Touch



| Radna ploča (mm)   |             |
|--------------------|-------------|
| 38/R6 x 600 x 4200 | 10012506810 |

| Kutna letva / setovi kutnika |             |
|------------------------------|-------------|
| Trokutastog presjeka         | 10015802230 |
| tip 56                       | 10015710260 |

| Laminat (mm)       |             |
|--------------------|-------------|
| Traka: 2090 x 42   | 10004807610 |
| Ploča: 4200 x 1300 | 10011306980 |

## 1461 Climb

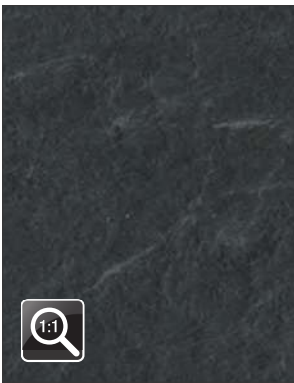

| Radna ploča (mm)     |             |
|----------------------|-------------|
| 38/R6 x 600 x 4200   | 10012506780 |
| Ploča stola (mm)     |             |
| 38/2*R6 x 900 x 4200 | 10001920240 |

| Kutna letva / setovi kutnika |             |
|------------------------------|-------------|
| Trokutastog presjeka         | 10015802215 |
| tip 56                       | 10015710230 |

| Laminat (mm)               |             |
|----------------------------|-------------|
| Traka: 2090 x 42           | 10004807580 |
| Ploča: 4200 x 1300         | 10011306950 |
| Rubna traka / narudžba: tm |             |
| Kod                        | 39335       |

## Fire Coat 3276 CLIFF

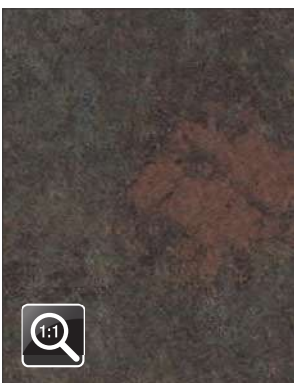

| Radna ploča (mm)   |             |
|--------------------|-------------|
| 38/R6 x 600 x 4200 | 10012506120 |

| Kutna letva / setovi kutnika |             |
|------------------------------|-------------|
| Trokutastog presjeka         | 10015801465 |
| tip 56                       | 10015710250 |

| Laminat (mm)               |             |
|----------------------------|-------------|
| Traka: 2090 x 42           | 10004806930 |
| Ploča: 4200 x 1300         | 10011306300 |
| Rubna traka / narudžba: tm |             |
| Kod                        | 39336       |

## Penelope FA33

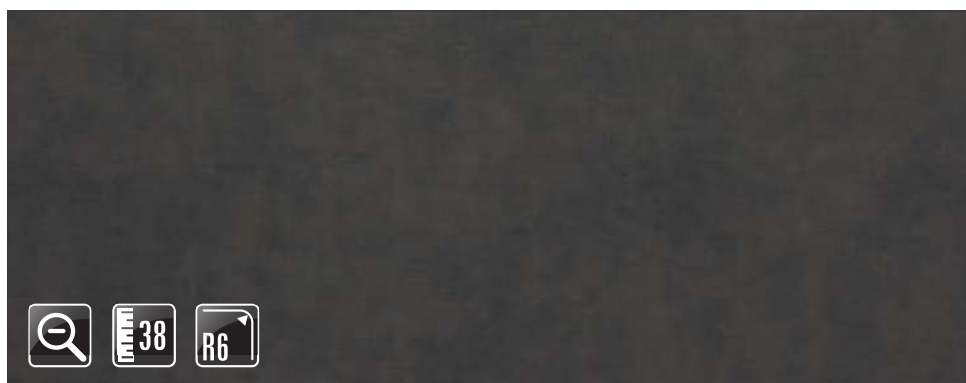
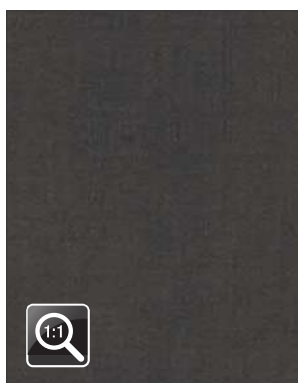

| Radna ploča (mm)     |             |
|----------------------|-------------|
| 38/R6 x 600 x 4200   | 10012506140 |
| Ploča stola (mm)     |             |
| 38/2*R6 x 900 x 4200 | 10001920230 |

| Kutna letva / setovi kutnika |             |
|------------------------------|-------------|
| Trokutastog presjeka         | 10015801475 |
| tip 56                       | 10015710250 |

| Laminat (mm)       |             |
|--------------------|-------------|
| Traka: 2090 x 42   | 10004806950 |
| Ploča: 4200 x 1300 | 10011306320 |

## Cemento Pietra A869 SIT

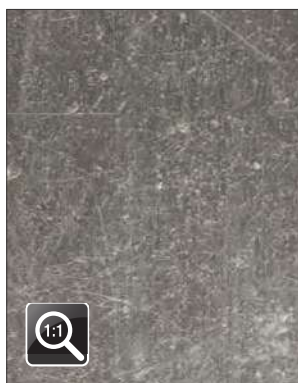

| Radna ploča (mm)   |             |
|--------------------|-------------|
| 38/R5 x 600 x 4200 | 10012506270 |

| Kutna letva / setovi kutnika |             |
|------------------------------|-------------|
| Trokutastog presjeka         | 10015801600 |
| tip 56                       | 10015710220 |

| Laminat (mm)       |             |
|--------------------|-------------|
| Traka: 2098 x 42   | 10004807080 |
| Ploča: 4200 x 2120 | 10011306450 |

## Flatting 4492

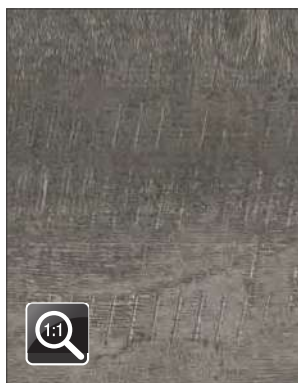

| Radna ploča (mm)   |             |
|--------------------|-------------|
| 38/R5 x 600 x 4200 | 10012506240 |

| Kutna letva / setovi kutnika |             |
|------------------------------|-------------|
| Trokutastog presjeka         | 10015801585 |
| tip 56                       | 10015710220 |

| Laminat (mm)               |             |
|----------------------------|-------------|
| Traka: 2098 x 42           | 10004807050 |
| Ploča: 4200 x 1305         | 10011306420 |
| Rubna traka / narudžba: tm |             |
| Kod                        | 34783       |



## Flatting 4490



| Radna ploča (mm)   |             |
|--------------------|-------------|
| 38/R5 x 600 x 4200 | 10012506250 |

| Kutna letva / setovi kutnika |             |
|------------------------------|-------------|
| Trokutastog presjeka         | 10015801590 |
| tip 56                       | 10015710260 |

| Laminat (mm)       |             |
|--------------------|-------------|
| Traka: 2098 x 42   | 10004807060 |
| Ploča: 4200 x 1300 | 10011306430 |

## Oksidirani čelik 4941 KS

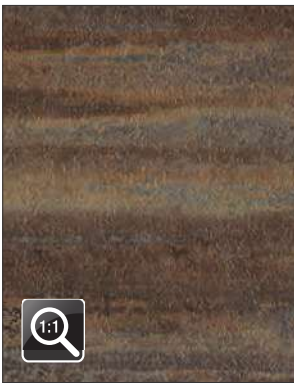

| Radna ploča (mm)   |             |
|--------------------|-------------|
| 38/R4 x 600 x 4200 | 10012506360 |

| Kutna letva / setovi kutnika |             |
|------------------------------|-------------|
| Trokutastog presjeka         | 10015801770 |
| tip 56                       | 10015710250 |

| Laminat (mm)       |             |
|--------------------|-------------|
| Traka: 2098 x 42   | 10004807160 |
| Ploča: 4200 x 1320 | 10011306530 |

## Pietra TN5



| Radna ploča (mm)   |             |
|--------------------|-------------|
| 38/R4 x 600 x 4200 | 10012506560 |

| Kutna letva / setovi kutnika |             |
|------------------------------|-------------|
| Trokutastog presjeka         | 10015801940 |
| tip 56                       | 10015710230 |

| Laminat (mm)       |             |
|--------------------|-------------|
| Traka: 4200 x 45   | 10004807360 |
| Ploča: 4200 x 2120 | 10011306730 |

## Bambu LK09 PORO

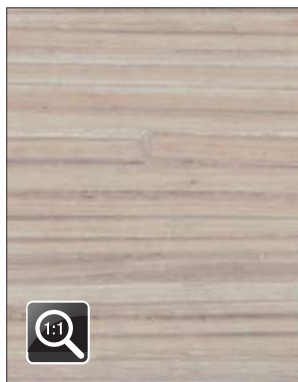

| Radna ploča (mm)   |             |
|--------------------|-------------|
| 38/R6 x 600 x 4200 | 10012506070 |

| Kutna letva / setovi kutnika |             |
|------------------------------|-------------|
| Trokutastog presjeka         | 10015801280 |
| tip 56                       | 10015710220 |

| Laminat (mm)               |             |
|----------------------------|-------------|
| Traka: 2090 x 42           | 10004806850 |
| Ploča: 4200 x 1310         | 10011306250 |
| Rubna traka / narudžba: tm |             |
| Kod                        | 35850       |

## Light Wood K5410 AW

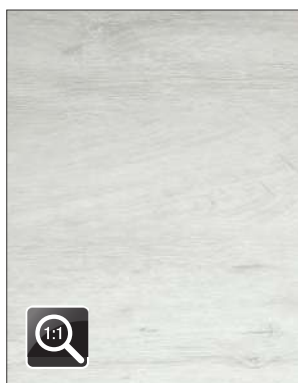

| Radna ploča (mm)   |             |
|--------------------|-------------|
| 39/R5 x 600 x 4200 | 10012506640 |

| Kutna letva / setovi kutnika |             |
|------------------------------|-------------|
| Trokutastog presjeka         | 10015802110 |
| tip 56                       | 10015710210 |

| Laminat (mm)               |             |
|----------------------------|-------------|
| Traka: 4200 x 45           | 10004807440 |
| Ploča: 4200 x 1350         | 10011306810 |
| Rubna traka / narudžba: tm |             |
| Kod                        | 35822       |

## Medium Wood K5415 AW

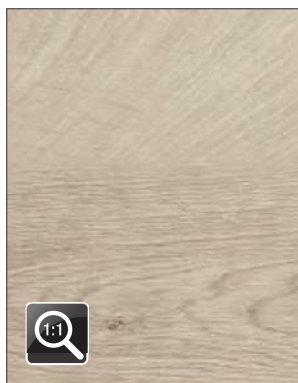

| Radna ploča (mm)   |             |
|--------------------|-------------|
| 39/R5 x 600 x 4200 | 10012506620 |

| Kutna letva / setovi kutnika |             |
|------------------------------|-------------|
| Trokutastog presjeka         | 10015802100 |
| tip 56                       | 10015710220 |

| Laminat (mm)               |             |
|----------------------------|-------------|
| Traka: 4200 x 45           | 10004807420 |
| Ploča: 4200 x 1350         | 10011306790 |
| Rubna traka / narudžba: tm |             |
| Kod                        | 35401       |

## Brown Wood K5414 AW



| Radna ploča (mm)   |             |
|--------------------|-------------|
| 39/R5 x 600 x 4200 | 10012506630 |

| Kutna letva / setovi kutnika |             |
|------------------------------|-------------|
| Trokutastog presjeka         | 10015802105 |
| tip 56                       | 10015710220 |

| Laminat (mm)               |             |
|----------------------------|-------------|
| Traka: 4200 x 45           | 10004807430 |
| Ploča: 4200 x 1350         | 10011306800 |
| Rubna traka / narudžba: tm |             |
| Kod                        | 34641       |

## Rovere Artico 670 Root



| Radna ploča (mm)     |             |
|----------------------|-------------|
| 38/R6 x 600 x 4200   | 10012506540 |
| Ploča stola (mm)     |             |
| 38/2*R6 x 900 x 4200 | 10001920170 |

| Kutna letva / setovi kutnika |             |
|------------------------------|-------------|
| Trokutastog presjeka         | 10015801930 |
| tip 56                       | 10015710230 |

| Laminat (mm)               |             |
|----------------------------|-------------|
| Traka: 2090 x 42           | 10004807340 |
| Ploča: 4200 x 1300         | 10011306710 |
| Rubna traka / narudžba: tm |             |
| Kod                        | 35114       |

## Everest 23L



| Radna ploča (mm)     |             |
|----------------------|-------------|
| 38/R6 x 600 x 4200   | 10012506580 |
| Ploča stola (mm)     |             |
| 38/2*R6 x 900 x 4200 | 10001920210 |

| Kutna letva / setovi kutnika |             |
|------------------------------|-------------|
| Trokutastog presjeka         | 10015801950 |
| tip 56                       | 10015710260 |

| Laminat (mm)               |             |
|----------------------------|-------------|
| Traka: 2090 x 42           | 10004807380 |
| Ploča: 4200 x 1300         | 10011306750 |
| Rubna traka / narudžba: tm |             |
| Kod                        | 34632       |



## Everest 24L

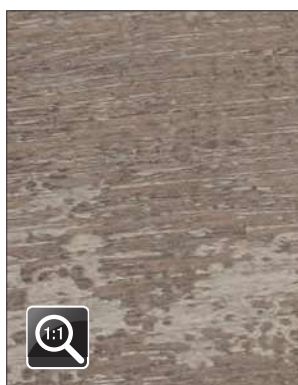

| Radna ploča (mm)     |             |
|----------------------|-------------|
| 38/R6 x 600 x 4200   | 10012506590 |
| Ploča stola (mm)     |             |
| 38/2*R6 x 900 x 4200 | 10001920220 |

| Kutna letva / setovi kutnika |             |
|------------------------------|-------------|
| Trokutastog presjeka         | 10015801955 |
| tip 56                       | 10015710230 |

| Laminat (mm)       |             |
|--------------------|-------------|
| Traka: 2090 x 42   | 10004807390 |
| Ploča: 4200 x 1300 | 10011306760 |

## Rovere Slavonia 4587 Alevé

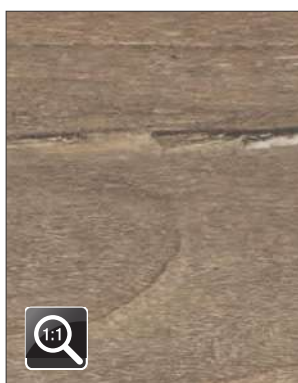

| Radna ploča (mm)     |             |
|----------------------|-------------|
| 38/R8 x 600 x 4200   | 10012506501 |
| Ploča stola (mm)     |             |
| 38/2*R8 x 900 x 4200 | 10001920160 |

| Kutna letva / setovi kutnika |             |
|------------------------------|-------------|
| Trokutastog presjeka         | 10015801910 |
| tip 56                       | 10015710240 |

| Laminat (mm)               |             |
|----------------------------|-------------|
| Traka: 2090 x 42           | 10004807300 |
| Ploča: 4200 x 1300         | 10011306670 |
| Rubna traka / narudžba: tm |             |
| Kod                        | 34641       |

## Rustikalna jela 4134 WH

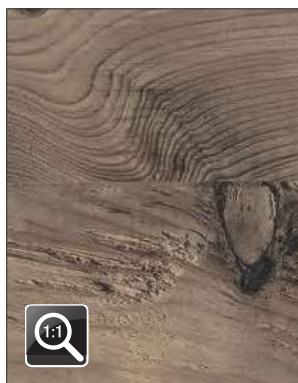

| Radna ploča (mm)   |             |
|--------------------|-------------|
| 38/R4 x 600 x 4200 | 10012506390 |

| Kutna letva / setovi kutnika |             |
|------------------------------|-------------|
| Trokutastog presjeka         | 10015801785 |
| tip 56                       | 10015710220 |

| Laminat (mm)               |             |
|----------------------------|-------------|
| Traka: 2098 x 42           | 10004807190 |
| Ploča: 4200 x 1320         | 10011306560 |
| Rubna traka / narudžba: tm |             |
| Kod                        | 34619       |

## Hrast antikni 4155 WH

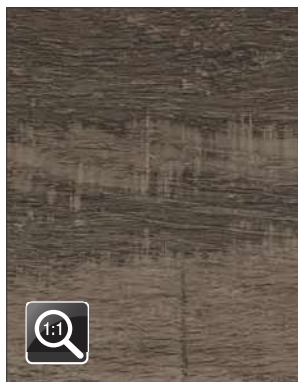

| Radna ploča (mm)   |             |
|--------------------|-------------|
| 38/R4 x 600 x 4200 | 10012506410 |

| Kutna letva / setovi kutnika |             |
|------------------------------|-------------|
| Trokutastog presjeka         | 10015801795 |
| tip 56                       | 10015710220 |

| Laminat (mm)               |             |
|----------------------------|-------------|
| Traka: 2098 x 42           | 10004807210 |
| Ploča: 4200 x 1320         | 10011306580 |
| Rubna traka / narudžba: tm |             |
| Kod                        | 34619       |

## Byblos Pine 789 Plamky

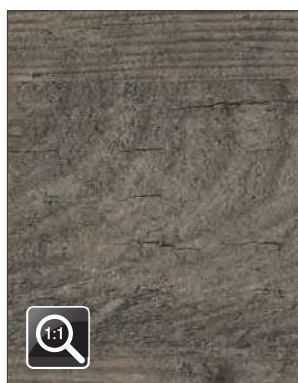

| Radna ploča (mm)   |             |
|--------------------|-------------|
| 38/R5 x 600 x 4200 | 10012506380 |

| Kutna letva / setovi kutnika |             |
|------------------------------|-------------|
| Trokutastog presjeka         | 10015801780 |
| tip 56                       | 10015710250 |

| Laminat (mm)               |             |
|----------------------------|-------------|
| Traka: 2098 x 42           | 10004807180 |
| Ploča: 4200 x 1305         | 10011306550 |
| Rubna traka / narudžba: tm |             |
| Kod                        | 34761       |

## Olmo Wood 677 Root

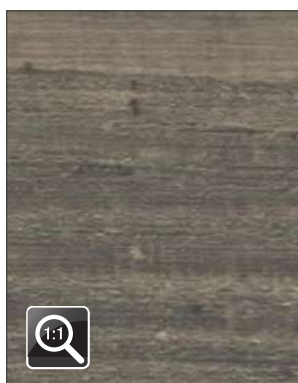

| Radna ploča (mm)   |             |
|--------------------|-------------|
| 38/R6 x 600 x 4200 | 10012506510 |

| Kutna letva / setovi kutnika |             |
|------------------------------|-------------|
| Trokutastog presjeka         | 10015801915 |
| tip 56                       | 10015710250 |

| Laminat (mm)               |             |
|----------------------------|-------------|
| Traka: 2090 x 42           | 10004807310 |
| Ploča: 4200 x 1300         | 10011306680 |
| Rubna traka / narudžba: tm |             |
| Kod                        | 34785       |



## Evo TN4

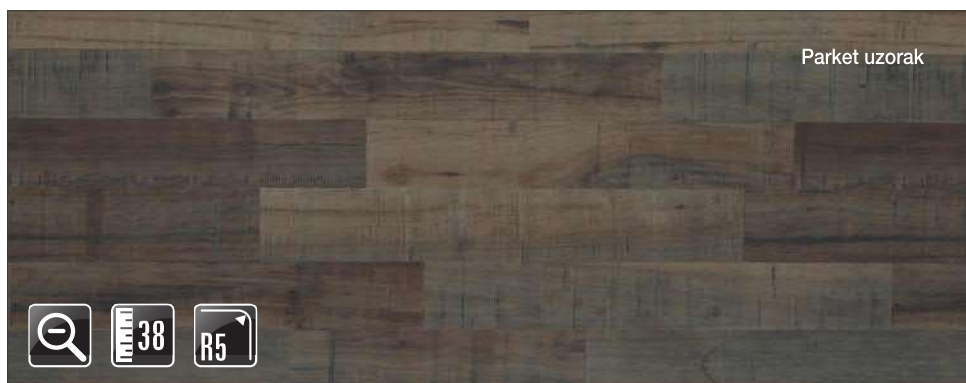
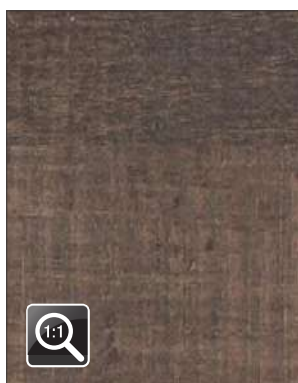

| Radna ploča (mm)   |             |
|--------------------|-------------|
| 38/R5 x 600 x 4200 | 10012506520 |

| Kutna letva / setovi kutnika |             |
|------------------------------|-------------|
| Trokutastog presjeka         | 10015801920 |
| tip 56                       | 10015710250 |

| Laminat (mm)               |             |
|----------------------------|-------------|
| Traka: 4200 x 45           | 10004807320 |
| Ploča: 4200 x 2120         | 10011306690 |
| Rubna traka / narudžba: tm |             |
| Kod                        | 35416       |

## Plamky 796

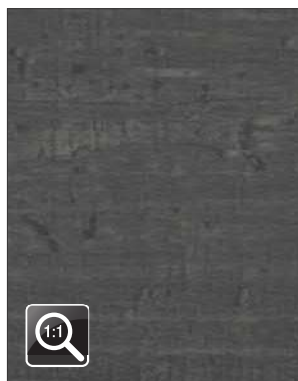

| Radna ploča (mm)   |             |
|--------------------|-------------|
| 38/R5 x 600 x 4200 | 10012506530 |

| Kutna letva / setovi kutnika |             |
|------------------------------|-------------|
| Trokutastog presjeka         | 10015801925 |
| tip 56                       | 10015710230 |

| Laminat (mm)               |             |
|----------------------------|-------------|
| Traka: 4200 x 45           | 10004807330 |
| Ploča: 4200 x 1305         | 10011306700 |
| Rubna traka / narudžba: tm |             |
| Kod                        | 34802       |



670 / H1486



## White Andromeda K217 GM

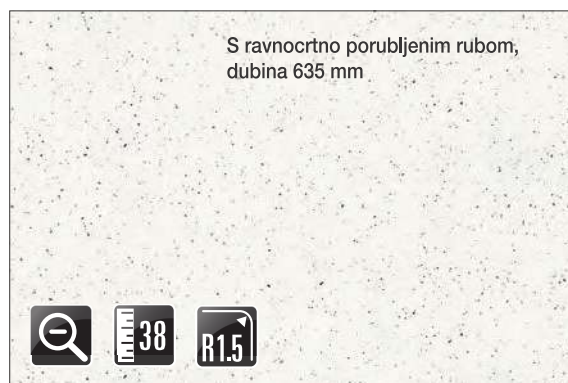

| Radna ploča (mm)     |             |
|----------------------|-------------|
| 38/R1,5 x 635 x 4100 | 10012556160 |
| Kutna letva          |             |
| Perfect Line         | 10015721210 |

| Perfect Line završni i kutni element |             |
|--------------------------------------|-------------|
| desni završni element                | 10015729002 |
| lijevi završni element               | 10015729052 |
| unutarnji kut 90°                    | 10015729102 |
| vanjski kut 90°                      | 10015729152 |

| Laminat (mm)               |             |
|----------------------------|-------------|
| Ploča: 4120 x 1350         | 10011320510 |
| Rubna traka / narudžba: tm |             |
| Kod                        | 38897       |

## Grey Andromeda K372 GM

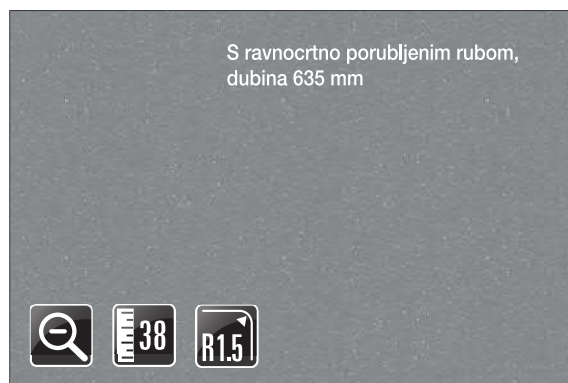

| Radna ploča (mm)     |             |
|----------------------|-------------|
| 38/R1,5 x 635 x 4100 | 10012556210 |
| Kutna letva          |             |
| Perfect Line         | 10015721220 |

| Perfect Line završni i kutni element |             |
|--------------------------------------|-------------|
| desni završni element                | 10015729001 |
| lijevi završni element               | 10015729051 |
| unutarnji kut 90°                    | 10015729101 |
| vanjski kut 90°                      | 10015729151 |

| Laminat (mm)               |             |
|----------------------------|-------------|
| Ploča: 4120 x 1350         | 10011320560 |
| Rubna traka / narudžba: tm |             |
| Kod                        | 38898       |

## Black Andromeda K218 GM



| Radna ploča (mm)     |             |
|----------------------|-------------|
| 38/R1,5 x 635 x 4100 | 10012556170 |
| Kutna letva          |             |
| Perfect Line         | 10015721230 |

| Perfect Line završni i kutni element |             |
|--------------------------------------|-------------|
| desni završni element                | 10015729007 |
| lijevi završni element               | 10015729057 |
| unutarnji kut 90°                    | 10015729107 |
| vanjski kut 90°                      | 10015729157 |

| Laminat (mm)               |             |
|----------------------------|-------------|
| Ploča: 4120 x 1350         | 10011320520 |
| Rubna traka / narudžba: tm |             |
| Kod                        | 38899       |

## Light Lunar Stone K103 SL



| Radna ploča (mm)     |             |
|----------------------|-------------|
| 38/R1,5 x 635 x 4100 | 10012557010 |
| Kutna letva          |             |
| Perfect Line         | 10015721170 |

| Perfect Line završni i kutni element |             |
|--------------------------------------|-------------|
| desni završni element                | 10015729004 |
| lijevi završni element               | 10015729054 |
| unutarnji kut 90°                    | 10015729104 |
| vanjski kut 90°                      | 10015729154 |

| Laminat (mm)               |             |
|----------------------------|-------------|
| Ploča: 4120 x 1350         | 10011320470 |
| Rubna traka / narudžba: tm |             |
| Kod                        | 39396       |

## Dark Lunar Stone K104 SL

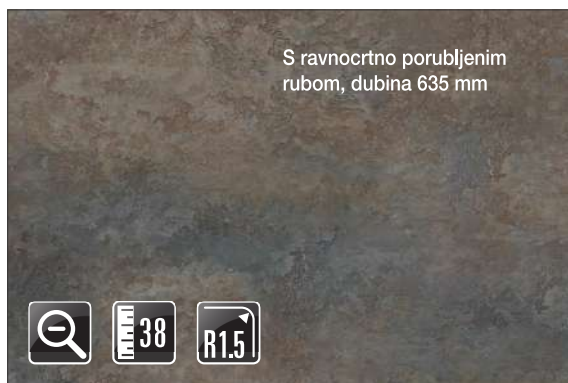
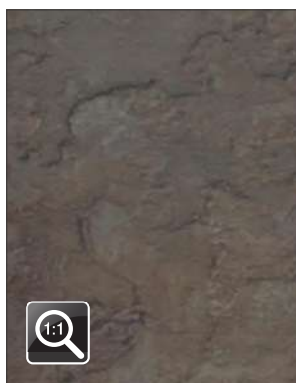

| Radna ploča (mm)     |             |
|----------------------|-------------|
| 38/R1,5 x 635 x 4100 | 10012557020 |
| Kutna letva          |             |
| Perfect Line         | 10015721180 |

| Perfect Line završni i kutni element |             |
|--------------------------------------|-------------|
| desni završni element                | 10015729008 |
| lijevi završni element               | 10015729058 |
| unutarnji kut 90°                    | 10015729108 |
| vanjski kut 90°                      | 10015729158 |

| Laminat (mm)               |             |
|----------------------------|-------------|
| Ploča: 4120 x 1350         | 10011320480 |
| Rubna traka / narudžba: tm |             |
| Kod                        | 39398       |

## Elegance Endgrain Oak K107 FP



| Radna ploča (mm)     |             |
|----------------------|-------------|
| 38/R1,5 x 635 x 4100 | 10012557040 |
| Kutna letva          |             |
| Perfect Line         | 10015720055 |

| Perfect Line završni i kutni element |             |
|--------------------------------------|-------------|
| desni završni element                | 10015729004 |
| lijevi završni element               | 10015729054 |
| unutarnji kut 90°                    | 10015729104 |
| vanjski kut 90°                      | 10015729154 |

| Laminat (mm)               |             |
|----------------------------|-------------|
| Ploča: 4120 x 1350         | 10011320500 |
| Rubna traka / narudžba: tm |             |
| Kod                        | 34652       |

## Raw Endgrain Oak K105 FP

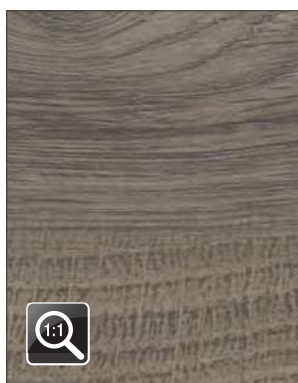

| Radna ploča (mm)     |             |
|----------------------|-------------|
| 38/R1,5 x 635 x 4100 | 10012557030 |
| Kutna letva          |             |
| Perfect Line         | 10015721190 |

| Perfect Line završni i kutni element |             |
|--------------------------------------|-------------|
| desni završni element                | 10015729005 |
| lijevi završni element               | 10015729055 |
| unutarnji kut 90°                    | 10015729105 |
| vanjski kut 90°                      | 10015729155 |

| Laminat (mm)               |             |
|----------------------------|-------------|
| Ploča: 4120 x 1350         | 10011320490 |
| Rubna traka / narudžba: tm |             |
| Kod                        | 34653       |



## White Andromeda K217 GG



| Radna ploča (mm)       |             |
|------------------------|-------------|
| 38/R3,3 x 600 x 4100   | 10012556130 |
| Ploča stola (mm)       |             |
| 38/2*R3,3 x 900 x 4100 | 10001930050 |
| Kutna letva            |             |
| Perfect Line           | 10015721130 |

| Setovi kutnika         |             |
|------------------------|-------------|
| desni završni element  | 10015729002 |
| lijevi završni element | 10015729052 |
| unutarnji kut 90°      | 10015729102 |
| vanjski kut 90°        | 10015729152 |

| Laminat (mm)       |             |
|--------------------|-------------|
| Traka: 4120 x 43   | 10004820330 |
| Ploča: 4120 x 1350 | 10011320430 |

Prikaz u smanjenoj veličini. Veličina uzorka 600 x 900 mm.



## Black Andromeda K218 GG



| Radna ploča (mm)       |             |
|------------------------|-------------|
| 38/R3,3 x 600 x 4100   | 10012556135 |
| Ploča stola (mm)       |             |
| 38/2*R3,3 x 900 x 4100 | 10001930060 |
| Kutna letva            |             |
| Perfect Line           | 10015721135 |

| Setovi kutnika         |             |
|------------------------|-------------|
| desni završni element  | 10015729007 |
| lijevi završni element | 10015729057 |
| unutarnji kut 90°      | 10015729107 |
| vanjski kut 90°        | 10015729157 |

| Laminat (mm)       |             |
|--------------------|-------------|
| Traka: 4120 x 43   | 10004820335 |
| Ploča: 4120 x 1350 | 10011320435 |

## White Dunes K215 BS

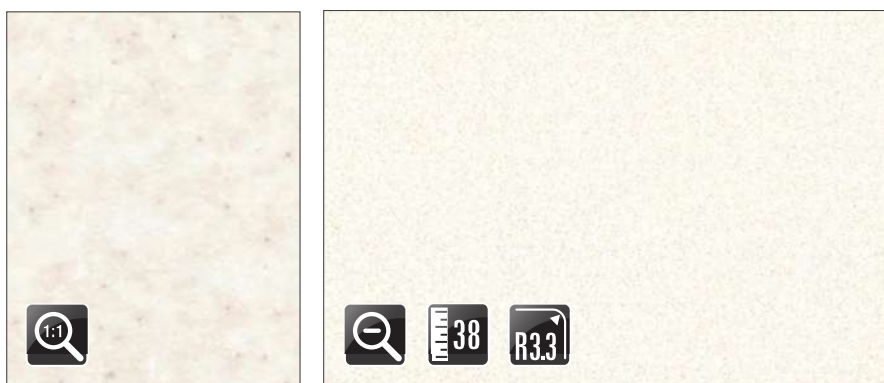

| Radna ploča (mm)     |             |
|----------------------|-------------|
| 38/R3,3 x 600 x 4100 | 10012556120 |
| Kutna letva          |             |
| Perfect Line         | 10015721120 |

| Perfect Line završni i kutni element |             |
|--------------------------------------|-------------|
| desni završni element                | 10015729002 |
| lijevi završni element               | 10015729052 |
| unutarnji kut 90°                    | 10015729102 |
| vanjski kut 90°                      | 10015729152 |

| Laminat (mm)       |             |
|--------------------|-------------|
| Traka: 4120 x 43   | 10004820320 |
| Ploča: 4120 x 1350 | 10011320420 |

## Light Terrazzo Marble K095 SU



| Radna ploča (mm)     |             |
|----------------------|-------------|
| 38/R3,3 x 600 x 4100 | 10012556050 |
| Kutna letva          |             |
| Perfect Line         | 10015721050 |

| Perfect Line završni i kutni element |             |
|--------------------------------------|-------------|
| desni završni element                | 10015729000 |
| lijevi završni element               | 10015729050 |
| unutarnji kut 90°                    | 10015729100 |
| vanjski kut 90°                      | 10015729150 |

| Laminat (mm)       |             |
|--------------------|-------------|
| Traka: 4120 x 43   | 10004820250 |
| Ploča: 4120 x 1350 | 10011320350 |

Prikaz u smanjenoj veličini. Veličina uzorka 600 x 900 mm.

Uz radne ploče sa ove stranice dajemo 1 kom laminatne trake 3110 x 45 mm.

## Cloud Nebula K369 PH



| Radna ploča (mm)     |             |
|----------------------|-------------|
| 38/R3,3 x 600 x 4100 | 10012556190 |
| Kutna letva          |             |
| Perfect Line         | 10015721240 |

| Perfect Line završni i kutni element |             |
|--------------------------------------|-------------|
| desni završni element                | 10015729008 |
| lijevi završni element               | 10015729058 |
| unutarnji kut 90°                    | 10015729108 |
| vanjski kut 90°                      | 10015729158 |

| Laminat (mm)       |             |
|--------------------|-------------|
| Traka: 4120 x 43   | 10004820440 |
| Ploča: 4120 x 1350 | 10011320540 |

## Beige Royal Marble K212 PA

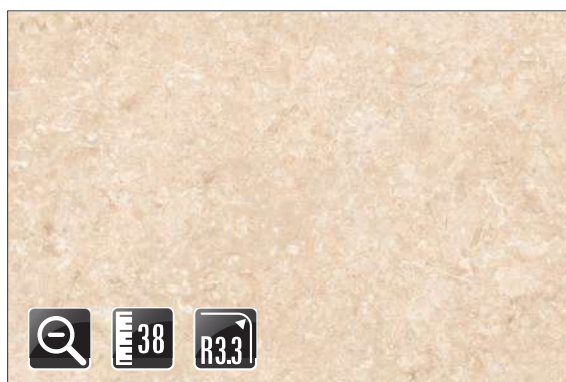

| Radna ploča (mm)       |             |
|------------------------|-------------|
| 38/R3,3 x 600 x 4100   | 10012556090 |
| Ploča stola (mm)       |             |
| 38/2*R3,3 x 900 x 4100 | 10001930070 |
| Kutna letva            |             |
| Perfect Line           | 10015721090 |

| Perfect Line završni i kutni element |             |
|--------------------------------------|-------------|
| desni završni element                | 10015729009 |
| lijevi završni element               | 10015729059 |
| unutarnji kut 90°                    | 10015729109 |
| vanjski kut 90°                      | 10015729159 |

| Laminat (mm)       |             |
|--------------------|-------------|
| Traka: 4120 x 43   | 10004820290 |
| Ploča: 4120 x 1350 | 10011320390 |

## White Valley Granite K371 PH



| Radna ploča (mm)     |             |
|----------------------|-------------|
| 38/R3,3 x 600 x 4100 | 10012556200 |
| Kutna letva          |             |
| Perfect Line         | 10015721250 |

| Perfect Line završni i kutni element |             |
|--------------------------------------|-------------|
| desni završni element                | 10015729000 |
| lijevi završni element               | 10015729050 |
| unutarnji kut 90°                    | 10015729100 |
| vanjski kut 90°                      | 10015729150 |

| Laminat (mm)       |             |
|--------------------|-------------|
| Traka: 4120 x 43   | 10004820450 |
| Ploča: 4120 x 1350 | 10011320550 |

Prikaz u smanjenoj veličini. Veličina uzorka 600 x 900 mm.  
Uz radne ploče sa ove stranice dajemo 1 kom laminatne trake 3110 x 45 mm.

## Crema Limestone K209 RS

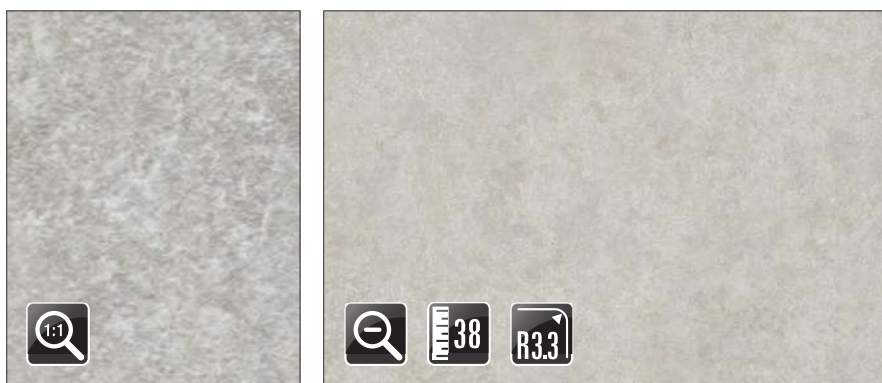

| Radna ploča (mm)     |             |
|----------------------|-------------|
| 38/R3,3 x 600 x 4100 | 10012556080 |
| Kutna letva          |             |
| Perfect Line         | 10015721080 |

| Perfect Line završni i kutni element |             |
|--------------------------------------|-------------|
| desni završni element                | 10015729000 |
| lijevi završni element               | 10015729050 |
| unutarnji kut 90°                    | 10015729100 |
| vanjski kut 90°                      | 10015729150 |

| Laminat (mm)       |             |
|--------------------|-------------|
| Traka: 4120 x 43   | 10004820280 |
| Ploča: 4120 x 1350 | 10011320380 |

## Grey Atlantic Marble K368 PH

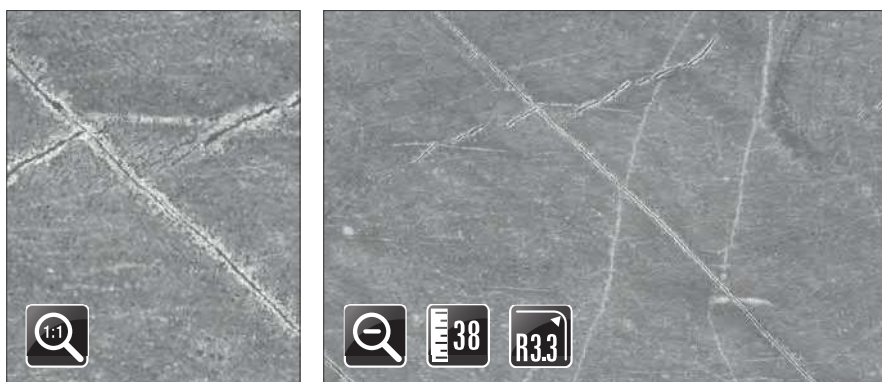

| Radna ploča (mm)     |             |
|----------------------|-------------|
| 38/R3,3 x 600 x 4100 | 10012556180 |
| Kutna letva          |             |
| Perfect Line         | 10015721260 |

| Perfect Line završni i kutni element |             |
|--------------------------------------|-------------|
| desni završni element                | 10015729001 |
| lijevi završni element               | 10015729051 |
| unutarnji kut 90°                    | 10015729101 |
| vanjski kut 90°                      | 10015729151 |

| Laminat (mm)       |             |
|--------------------|-------------|
| Traka: 4120 x 43   | 10004820430 |
| Ploča: 4120 x 1350 | 10011320530 |

## Grey Galaxy K207 RS



| Radna ploča (mm)     |             |
|----------------------|-------------|
| 38/R3,3 x 600 x 4100 | 10012556070 |
| Kutna letva          |             |
| Perfect Line         | 10015721070 |

| Perfect Line završni i kutni element |             |
|--------------------------------------|-------------|
| desni završni element                | 10015729001 |
| lijevi završni element               | 10015729051 |
| unutarnji kut 90°                    | 10015729101 |
| vanjski kut 90°                      | 10015729151 |

| Laminat (mm)       |             |
|--------------------|-------------|
| Traka: 4120 x 43   | 10004820270 |
| Ploča: 4120 x 1350 | 10011320370 |

Prikaz u smanjenoj veličini. Veličina uzorka 600 x 900 mm.

Uz radne ploče sa ove stranice dajemo 1 kom laminatne trake 3110 x 45 mm.



## Light Tivoli K214 RS

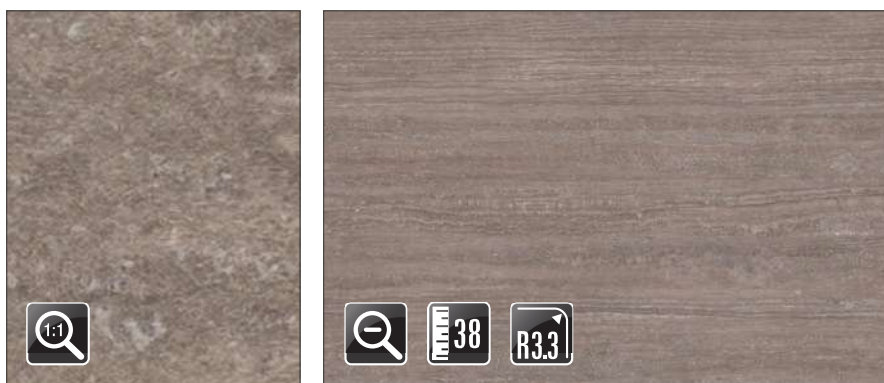

| Radna ploča (mm)     |             |
|----------------------|-------------|
| 38/R3,3 x 600 x 4100 | 10012556110 |
| Kutna letva          |             |
| Perfect Line         | 10015721110 |

| Perfect Line završni i kutni element |             |
|--------------------------------------|-------------|
| desni završni element                | 10015729004 |
| lijevi završni element               | 10015729054 |
| unutarnji kut 90°                    | 10015729104 |
| vanjski kut 90°                      | 10015729154 |

| Laminat (mm)       |             |
|--------------------|-------------|
| Traka: 4120 x 43   | 10004820310 |
| Ploča: 4120 x 1350 | 10011320410 |

## Dark Tivoli K213 RS



| Radna ploča (mm)     |             |
|----------------------|-------------|
| 38/R3,3 x 600 x 4100 | 10012556100 |
| Kutna letva          |             |
| Perfect Line         | 10015721100 |

| Perfect Line završni i kutni element |             |
|--------------------------------------|-------------|
| desni završni element                | 10015729010 |
| lijevi završni element               | 10015729060 |
| unutarnji kut 90°                    | 10015729110 |
| vanjski kut 90°                      | 10015729160 |

| Laminat (mm)       |             |
|--------------------|-------------|
| Traka: 4120 x 43   | 10004820300 |
| Ploča: 4120 x 1350 | 10011320400 |

## Light Atelier 4298 UE

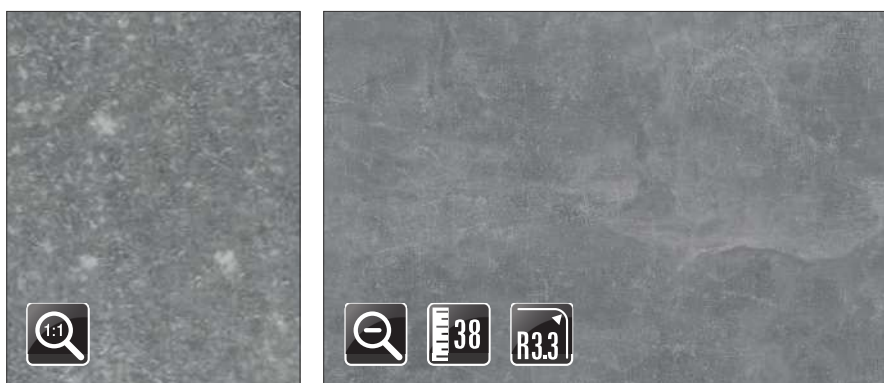

| Radna ploča (mm)     |             |
|----------------------|-------------|
| 38/R3,3 x 600 x 4100 | 10012556150 |
| Kutna letva          |             |
| Perfect Line         | 10015721150 |

| Perfect Line završni i kutni element |             |
|--------------------------------------|-------------|
| desni završni element                | 10015729001 |
| lijevi završni element               | 10015729051 |
| unutarnji kut 90°                    | 10015729101 |
| vanjski kut 90°                      | 10015729151 |

| Laminat (mm)       |             |
|--------------------|-------------|
| Traka: 4120 x 43   | 10004820350 |
| Ploča: 4120 x 1350 | 10011320450 |

Prikaz u smanjenoj veličini. Veličina uzorka 600 x 900 mm.  
Uz radne ploče sa ove stranice dajemo 1 kom laminatne trake 3110 x 45 mm.

## Dark Atelier 4299 UE



| Radna ploča (mm)     |             |
|----------------------|-------------|
| 38/R3,3 x 600 x 4100 | 10012556140 |
| Kutna letva          |             |
| Perfect Line         | 10015721140 |

| Perfect Line završni i kutni element |             |
|--------------------------------------|-------------|
| desni završni element                | 10015729010 |
| lijevi završni element               | 10015729060 |
| unutarnji kut 90°                    | 10015729110 |
| vanjski kut 90°                      | 10015729160 |

| Laminat (mm)       |             |
|--------------------|-------------|
| Traka: 4120 x 43   | 10004820340 |
| Ploča: 4120 x 1350 | 10011320440 |

## Grey Craft Oak K002 FP

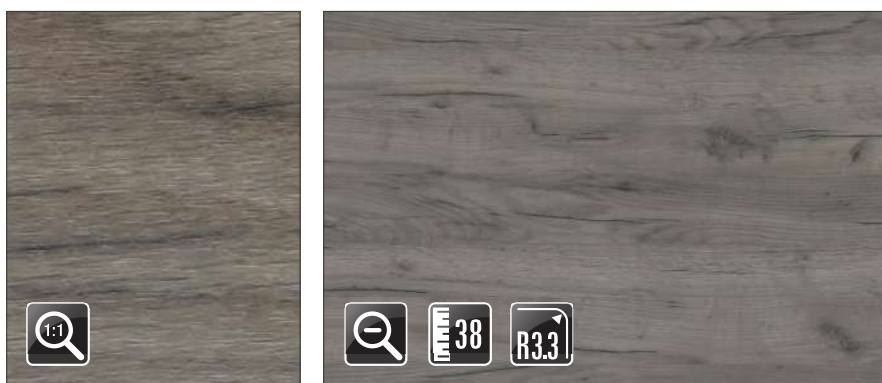

| Radna ploča (mm)     |             |
|----------------------|-------------|
| 38/R3,3 x 600 x 4100 | 10012556000 |
| Kutna letva          |             |
| Perfect Line         | 10015721000 |

| Perfect Line završni i kutni element |             |
|--------------------------------------|-------------|
| desni završni element                | 10015729008 |
| lijevi završni element               | 10015729058 |
| unutarnji kut 90°                    | 10015729108 |
| vanjski kut 90°                      | 10015729158 |

| Laminat (mm)               |             |
|----------------------------|-------------|
| Traka: 4120 x 43           | 10004820200 |
| Ploča: 4120 x 1350         | 10011320300 |
| Rubna traka / narudžba: tm |             |
| Kod                        | 34594       |

## Gold Craft Oak K003 FP

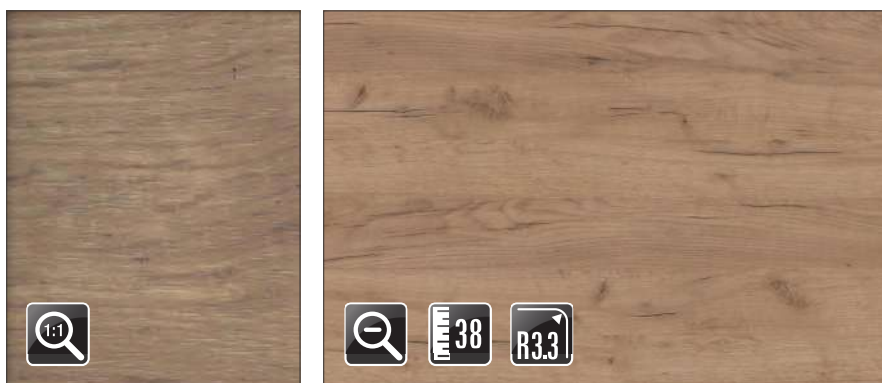

| Radna ploča (mm)       |             |
|------------------------|-------------|
| 38/R3,3 x 600 x 4100   | 10012556010 |
| Ploča stola (mm)       |             |
| 38/2*R3,3 x 900 x 4100 | 10001930080 |
| Kutna letva            |             |
| Perfect Line           | 10015721010 |

| Perfect Line završni i kutni element |             |
|--------------------------------------|-------------|
| desni završni element                | 10015729006 |
| lijevi završni element               | 10015729056 |
| unutarnji kut 90°                    | 10015729106 |
| vanjski kut 90°                      | 10015729156 |

| Laminat (mm)               |             |
|----------------------------|-------------|
| Traka: 4120 x 43           | 10004820210 |
| Ploča: 4120 x 1350         | 10011320310 |
| Rubna traka / narudžba: tm |             |
| Kod                        | 34641       |

Prikaz u smanjenoj veličini. Veličina uzorka 600 x 900 mm.

Uz radne ploče sa ove stranice dajemo 1 kom laminatne trake 3110 x 45 mm.

## Linen Block Wood K029 SU

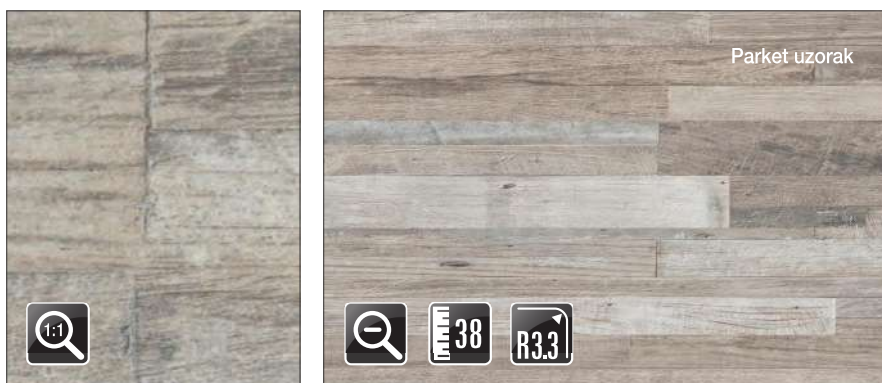

| Radna ploča (mm)     |             |
|----------------------|-------------|
| 38/R3,3 x 600 x 4100 | 10012556020 |
| Kutna letva          |             |
| Perfect Line         | 10015721020 |

| Perfect Line završni i kutni element |             |
|--------------------------------------|-------------|
| desni završni element                | 10015729008 |
| lijevi završni element               | 10015729058 |
| unutarnji kut 90°                    | 10015729108 |
| vanjski kut 90°                      | 10015729158 |

| Laminat (mm)       |             |
|--------------------|-------------|
| Traka: 4120 x 43   | 10004820220 |
| Ploča: 4120 x 1350 | 10011320320 |

## Light Porterhouse Oak K091 FP

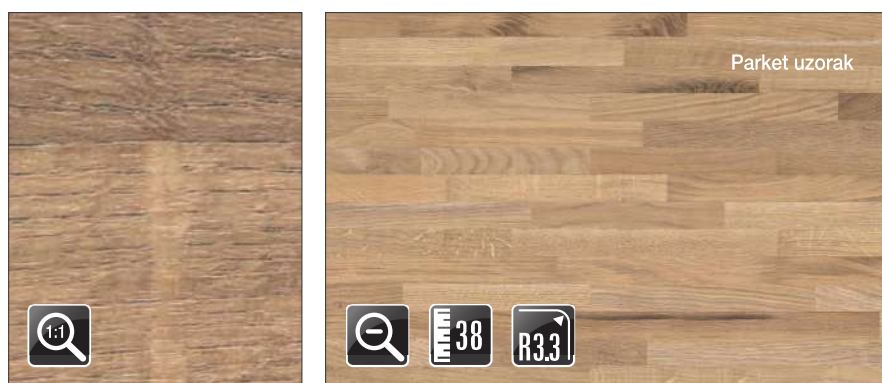

| Radna ploča (mm)     |             |
|----------------------|-------------|
| 38/R3,3 x 600 x 4100 | 10012556030 |
| Kutna letva          |             |
| Perfect Line         | 10015721030 |

| Perfect Line završni i kutni element |             |
|--------------------------------------|-------------|
| desni završni element                | 10015729006 |
| lijevi završni element               | 10015729056 |
| unutarnji kut 90°                    | 10015729106 |
| vanjski kut 90°                      | 10015729156 |

| Laminat (mm)       |             |
|--------------------|-------------|
| Traka: 4120 x 43   | 10004820230 |
| Ploča: 4120 x 1350 | 10011320330 |

## Dark Porterhouse Oak K092 FP

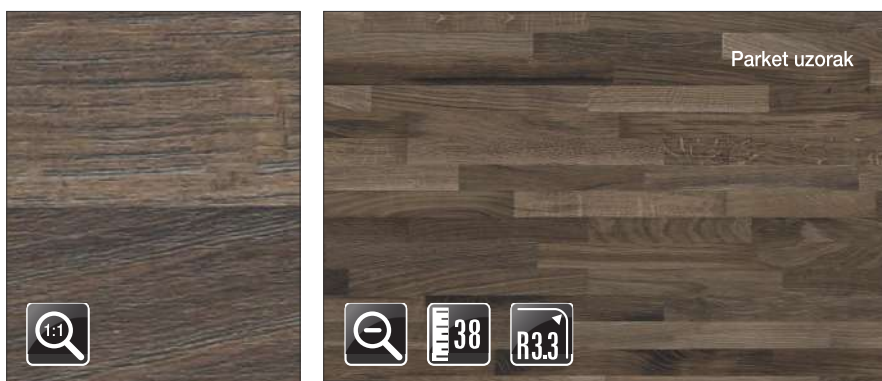

| Radna ploča (mm)     |             |
|----------------------|-------------|
| 38/R3,3 x 600 x 4100 | 10012556040 |
| Kutna letva          |             |
| Perfect Line         | 10015721040 |

| Perfect Line završni i kutni element |             |
|--------------------------------------|-------------|
| desni završni element                | 10015729005 |
| lijevi završni element               | 10015729055 |
| unutarnji kut 90°                    | 10015729105 |
| vanjski kut 90°                      | 10015729155 |

| Laminat (mm)       |             |
|--------------------|-------------|
| Traka: 4120 x 43   | 10004820240 |
| Ploča: 4120 x 1350 | 10011320340 |

Prikaz u smanjenoj veličini. Veličina uzorka 600 x 900 mm.  
Uz radne ploče sa ove stranice dajemo 1 kom laminatne trake 3110 x 45 mm.



## Bianco 2252 FC

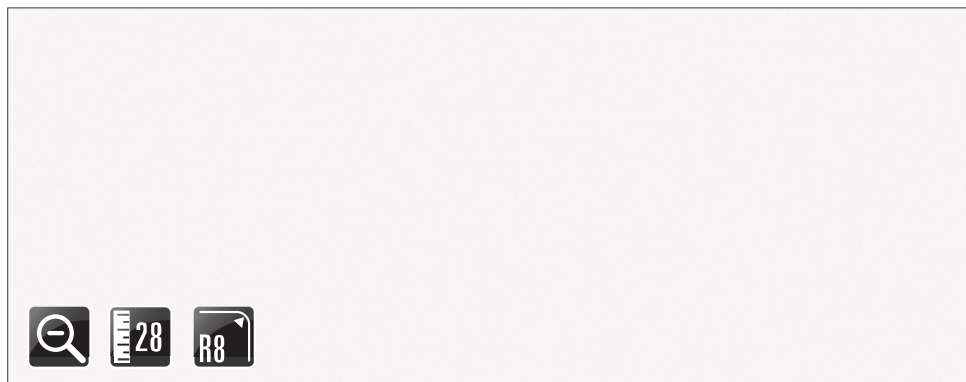
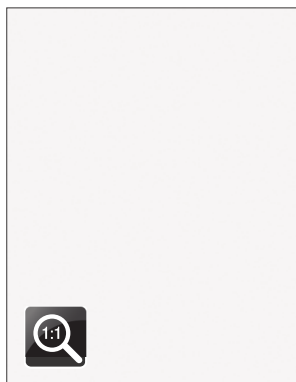

| Radna ploča (mm)   |             |
|--------------------|-------------|
| 28/R8 x 600 x 4200 | 10012500101 |
| Ploča stola (mm)   |             |
| 28/R8 x 800 x 4200 | 10001902100 |

| Kutna letva / setovi kutnika |             |
|------------------------------|-------------|
| Trokutastog presjeka         | 10015800020 |
| tip 56                       | 10015710210 |
| S kabel kanalom              | 10015701100 |
| tip 53                       | 10015701200 |

| Laminat (mm)               |             |
|----------------------------|-------------|
| Traka: 2090 x 32           | 10004800100 |
| Ploča: 4200 x 1300         | 10011300500 |
| Rubna traka / narudžba: tm |             |
| Kod                        | 30030       |

## Stone Black 5078 Crystal

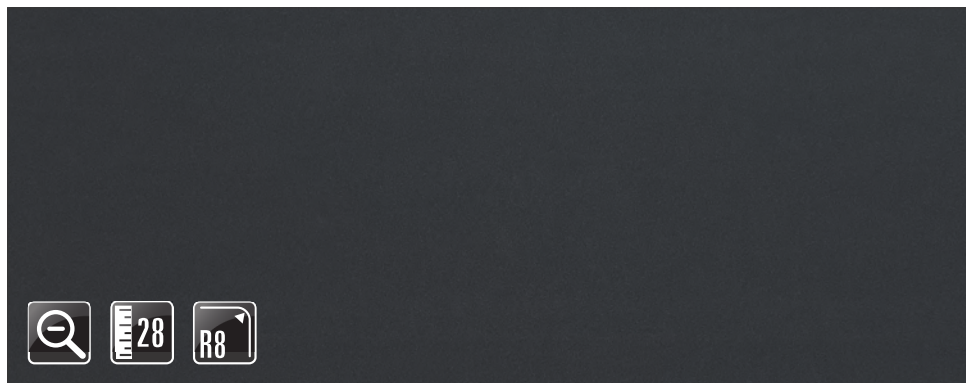
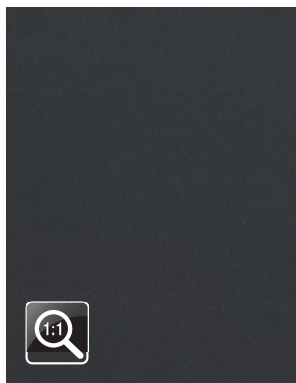

| Radna ploča (mm)  |             |
|-------------------|-------------|
| 28/R x 600 x 4200 | 10012503910 |

| Kutna letva / setovi kutnika |             |
|------------------------------|-------------|
| Trokutastog presjeka         | 10015800282 |
| tip 56                       | 10015710260 |

| Laminat (mm)       |             |
|--------------------|-------------|
| Traka: 2090 x 32   | 10004804010 |
| Ploča: 4200 x 1300 | 10011305610 |

## Chip Sand 4793 TP



| Radna ploča (mm)   |             |
|--------------------|-------------|
| 28/R8 x 600 x 4200 | 10012500531 |
| Ploča stola (mm)   |             |
| 28/R8 x 800 x 4200 | 10001900151 |

| Kutna letva / setovi kutnika |             |
|------------------------------|-------------|
| Trokutastog presjeka         | 10015800050 |
| tip 56                       | 10015710220 |

| Laminat (mm)       |             |
|--------------------|-------------|
| Traka: 2090 x 32   | 10004800541 |
| Ploča: 4200 x 1300 | 10011300321 |

## Granit 934 GL

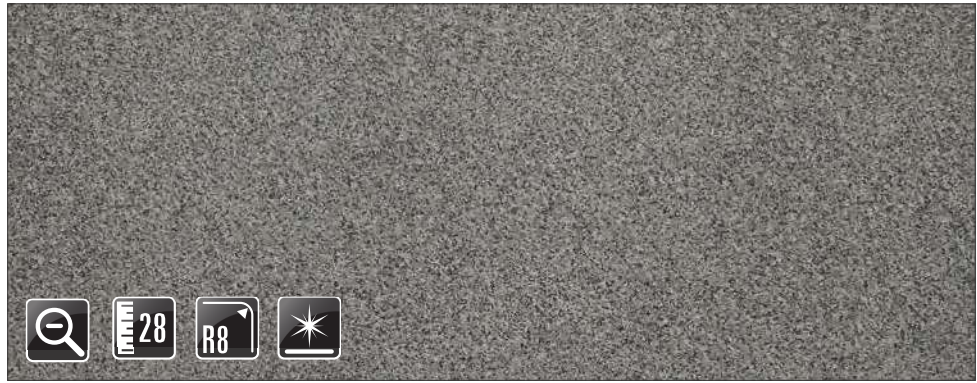

| Radna ploča (mm)   |             |
|--------------------|-------------|
| 28/R8 x 600 x 4200 | 10012501402 |

| Kutna letva / setovi kutnika |             |
|------------------------------|-------------|
| Trokutastog presjeka         | 10015800115 |
| tip 56                       | 10015710240 |

| Laminat (mm)       |             |
|--------------------|-------------|
| Traka: 2090 x 32   | 10004801402 |
| Ploča: 4200 x 1300 | 10011302603 |

## Granit 934 TP

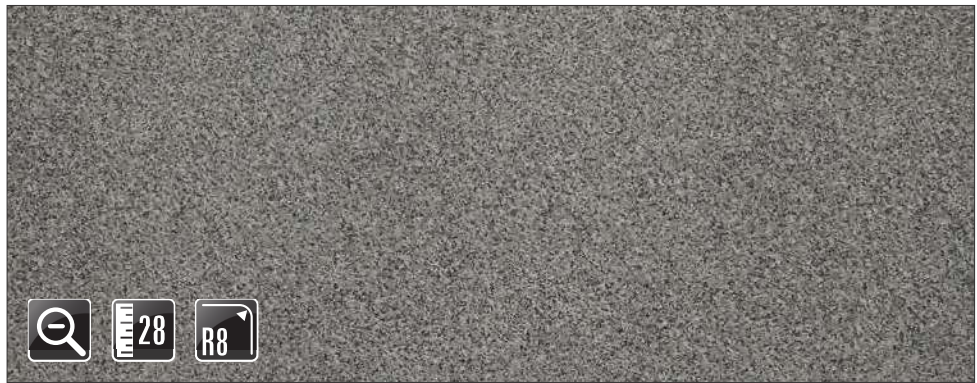

| Radna ploča (mm)   |             |
|--------------------|-------------|
| 28/R8 x 600 x 4200 | 10012501502 |

| Kutna letva / setovi kutnika |             |
|------------------------------|-------------|
| Trokutastog presjeka         | 10015800116 |
| tip 56                       | 10015710240 |

| Laminat (mm)       |             |
|--------------------|-------------|
| Traka: 2090 x 32   | 10004801502 |
| Ploča: 4200 x 1300 | 10011302702 |

## Nero Africa 1027 GL

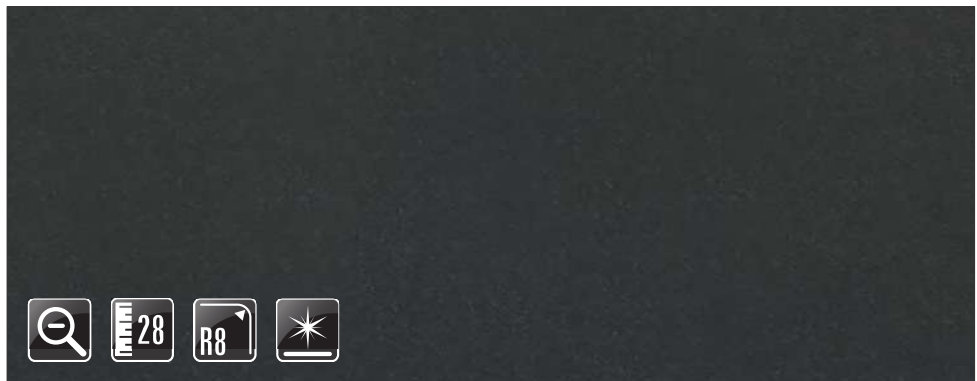

| Radna ploča (mm)   |             |
|--------------------|-------------|
| 28/R8 x 600 x 4200 | 10012503002 |

| Kutna letva / setovi kutnika |             |
|------------------------------|-------------|
| Trokutastog presjeka         | 10015800197 |
| tip 56                       | 10015710260 |

| Laminat (mm)       |             |
|--------------------|-------------|
| Traka: 2090 x 32   | 10004803102 |
| Ploča: 4200 x 1300 | 10011304310 |

## Nero Africa 1027 TF

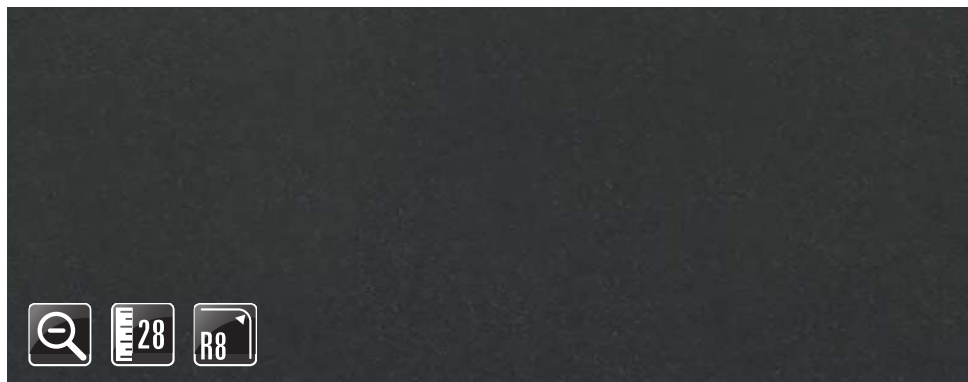

| Radna ploča (mm)   |             |
|--------------------|-------------|
| 28/R8 x 600 x 4200 | 10012503102 |

| Kutna letva / setovi kutnika |             |
|------------------------------|-------------|
| Trokutastog presjeka         | 10015800198 |
| tip 56                       | 10015710260 |

| Laminat (mm)       |             |
|--------------------|-------------|
| Traka: 2090 x 32   | 10004803202 |
| Ploča: 4200 x 1300 | 10011304320 |

## Marble 4828 GL

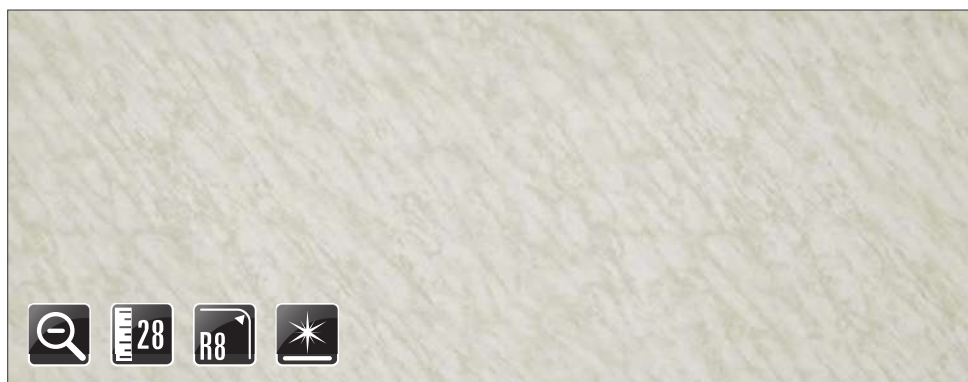
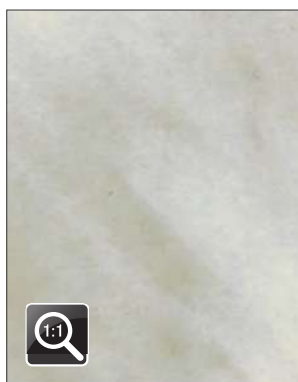

| Radna ploča (mm)   |             |
|--------------------|-------------|
| 28/R8 x 600 x 4200 | 10012502301 |

| Kutna letva / setovi kutnika |             |
|------------------------------|-------------|
| Trokutastog presjeka         | 10015800170 |
| tip 56                       | 10015710210 |

| Laminat (mm)       |             |
|--------------------|-------------|
| Traka: 2090 x 32   | 10004802401 |
| Ploča: 4200 x 1300 | 10011303601 |

## Marble 4828 QZ



| Radna ploča (mm)   |             |
|--------------------|-------------|
| 28/R8 x 600 x 4200 | 10012502401 |

| Kutna letva / setovi kutnika |             |
|------------------------------|-------------|
| Trokutastog presjeka         | 10015800171 |
| tip 56                       | 10015710210 |
| S kabel kanalom              | 10015700600 |
| tip 53                       | 10015701200 |

| Laminat (mm)       |             |
|--------------------|-------------|
| Traka: 2090 x 32   | 10004802501 |
| Ploča: 4200 x 1300 | 10011303701 |



## Bijeli mramor 0457 GL



| Radna ploča (mm)   |             |
|--------------------|-------------|
| 28/R8 x 600 x 4200 | 10012560210 |

| Kutna letva / setovi kutnika |             |
|------------------------------|-------------|
| Trokutastog presjeka         | 10015801515 |
| tip 56                       | 10015710220 |

| Laminat (mm)       |             |
|--------------------|-------------|
| Traka: 2090 x 32   | 10004821110 |
| Traka: 4200 x 32   | 10004821115 |
| Ploča: 4200 x 1300 | 10011321110 |

## Onyx Naturale 6350 GL

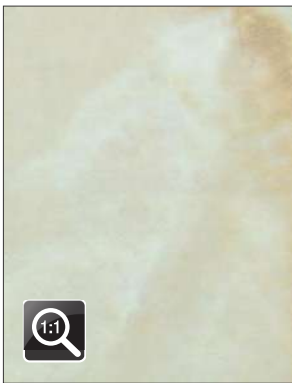

| Radna ploča (mm)   |             |
|--------------------|-------------|
| 28/R8 x 600 x 4200 | 10012503132 |

| Kutna letva / setovi kutnika |             |
|------------------------------|-------------|
| Trokutastog presjeka         | 10015800200 |
| tip 56                       | 10015710220 |

| Laminat (mm)       |             |
|--------------------|-------------|
| Traka: 2090 x 32   | 10004803322 |
| Ploča: 4200 x 1300 | 10011305981 |

## Salome Bež 3170 GL



| Radna ploča (mm)   |             |
|--------------------|-------------|
| 28/R8 x 600 x 4200 | 10012503720 |
| Ploča stola (mm)   |             |
| 28/R8 x 800 x 4200 | 10001901860 |

| Kutna letva / setovi kutnika |             |
|------------------------------|-------------|
| Trokutastog presjeka         | 10015800250 |
| tip 56                       | 10015710220 |

| Laminat (mm)       |             |
|--------------------|-------------|
| Traka: 2100 x 32   | 10004803820 |
| Ploča: 4200 x 1300 | 10011305420 |

## Salome Bež 3170 TF

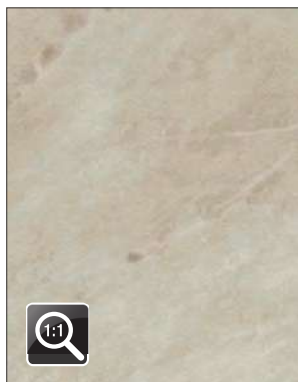

| Radna ploča (mm)   |             |
|--------------------|-------------|
| 28/R8 x 600 x 4200 | 10012503725 |
| Ploča stola (mm)   |             |
| 28/R8 x 800 x 4200 | 10001901861 |

| Kutna letva / setovi kutnika |             |
|------------------------------|-------------|
| Trokutastog presjeka         | 10015800251 |
| tip 56                       | 10015710220 |

| Laminat (mm)       |             |
|--------------------|-------------|
| Traka: 2100 x 32   | 10004803825 |
| Ploča: 4200 x 1300 | 10011305425 |

## Bež mramor 4853 GL

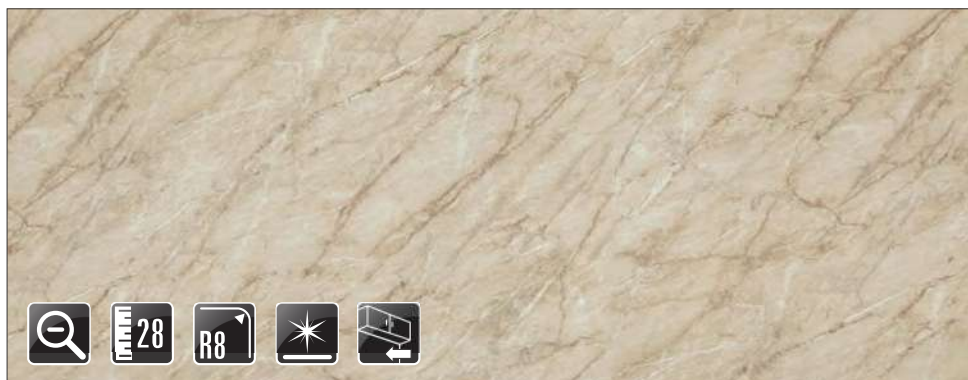
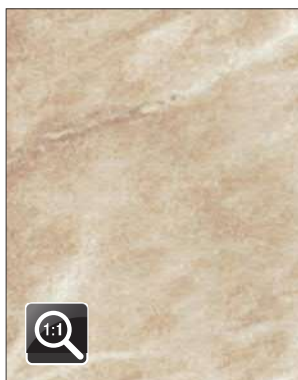

| Radna ploča (mm)            |             |
|-----------------------------|-------------|
| 28/R8 x 600 x 4200          | 10012505060 |
| Kuhinjska zidna obloga (mm) |             |
| 8 x 645 x 4200              | 10012592020 |

| Kutna letva / setovi kutnika |             |
|------------------------------|-------------|
| Trokutastog presjeka         | 10015801530 |
| tip 56                       | 10015710220 |

| Laminat (mm)       |             |
|--------------------|-------------|
| Traka: 2090 x 32   | 10004806900 |
| Ploča: 4200 x 1300 | 10011306015 |

## Salome Noce 3200 GL

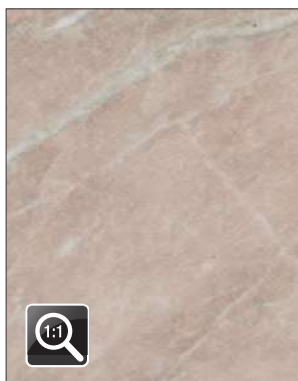

| Radna ploča (mm)   |             |
|--------------------|-------------|
| 28/R8 x 600 x 4200 | 10012503726 |

| Kutna letva / setovi kutnika |             |
|------------------------------|-------------|
| Trokutastog presjeka         | 10015800255 |
| tip 56                       | 10015710220 |

| Laminat (mm)       |             |
|--------------------|-------------|
| Traka: 2100 x 32   | 10004803826 |
| Ploča: 4200 x 1300 | 10011305426 |

## Salome Noce 3200 TF

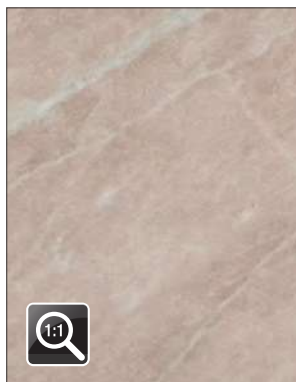

| Radna ploča (mm)   |             |
|--------------------|-------------|
| 28/R8 x 600 x 4200 | 10012503727 |

| Kutna letva / setovi kutnika |             |
|------------------------------|-------------|
| Trokutastog presjeka         | 10015800256 |
| tip 56                       | 10015710220 |

| Laminat (mm)       |             |
|--------------------|-------------|
| Traka: 2100 x 32   | 10004803827 |
| Ploča: 4200 x 1300 | 10011305427 |

## Smeđi mramor 4854 GL

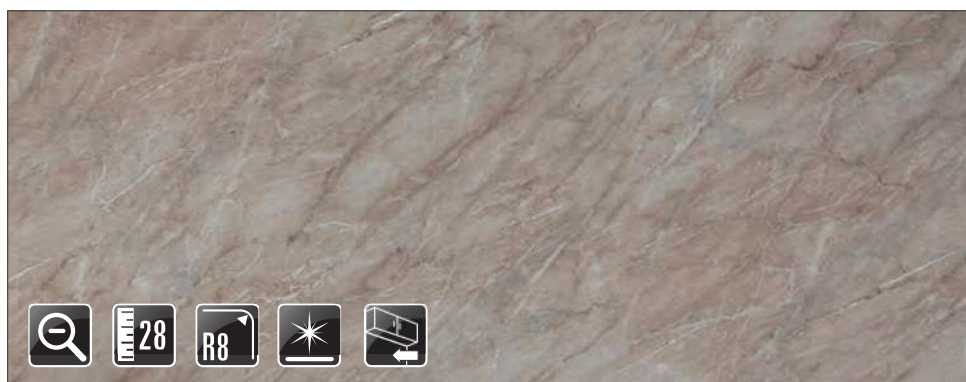
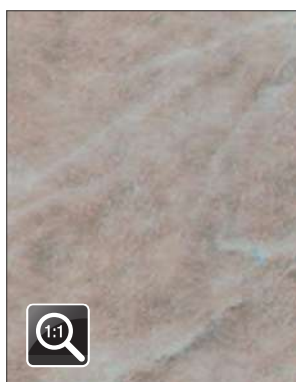

| Radna ploča (mm)            |             |
|-----------------------------|-------------|
| 28/R8 x 600 x 4200          | 10012505070 |
| Kuhinjska zidna obloga (mm) |             |
| 8 x 645 x 4200              | 10012592030 |

| Kutna letva / setovi kutnika |             |
|------------------------------|-------------|
| Trokutastog presjeka         | 10015801525 |
| tip 56                       | 10015710220 |

| Laminat (mm)       |             |
|--------------------|-------------|
| Traka: 2090 x 32   | 10004806910 |
| Ploča: 4200 x 1300 | 10011306020 |

## Sand Mohave 9893 GL

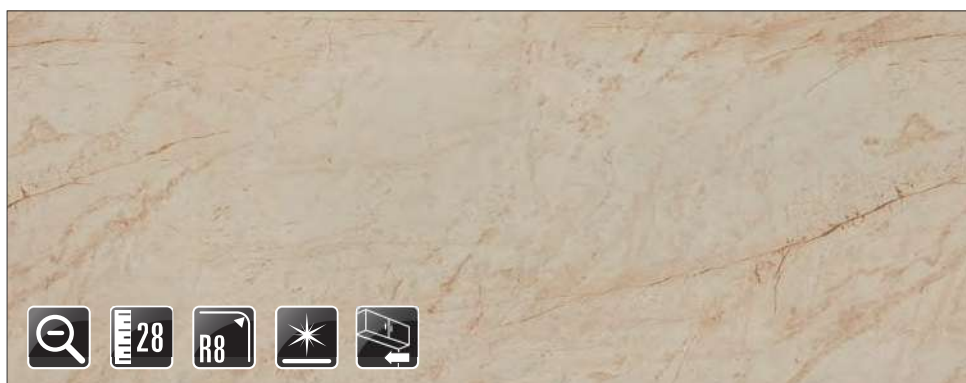

| Radna ploča (mm)            |             |
|-----------------------------|-------------|
| 28/R8 x 600 x 4200          | 10012503752 |
| Ploča stola (mm)            |             |
| 28/R8 x 800 x 4200          | 10001901871 |
| Kuhinjska zidna obloga (mm) |             |
| 8 x 645 x 4200              | 10012592000 |

| Kutna letva / setovi kutnika |             |
|------------------------------|-------------|
| Trokutastog presjeka         | 10015800270 |
| tip 56                       | 10015710220 |

| Laminat (mm)       |             |
|--------------------|-------------|
| Traka: 2090 x 32   | 10004803842 |
| Ploča: 4200 x 1300 | 10011305462 |



## Sand Mohave 9893 Cedro

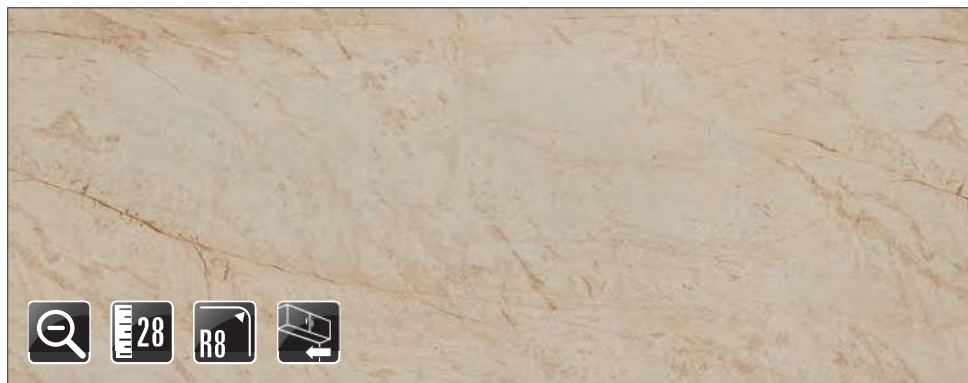

| Radna ploča (mm)            |             |
|-----------------------------|-------------|
| 28/R8 x 600 x 4200          | 10012503753 |
| Kuhinjska zidna obloga (mm) |             |
| 8 x 645 x 4200              | 10012592010 |

| Kutna letva / setovi kutnika |             |
|------------------------------|-------------|
| Trokutastog presjeka         | 10015800271 |
| tip 56                       | 10015710220 |

| Laminat (mm)       |             |
|--------------------|-------------|
| Traka: 2090 x 32   | 10004803843 |
| Ploča: 4200 x 1300 | 10011305463 |

## Sivi mramor 1441 GL

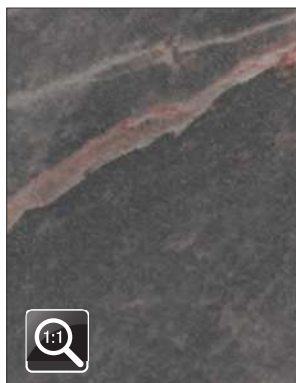

| Radna ploča (mm)   |             |
|--------------------|-------------|
| 28/R8 x 600 x 4200 | 10012560250 |

| Kutna letva / setovi kutnika |             |
|------------------------------|-------------|
| Trokutastog presjeka         | 10015801536 |
| tip 56                       | 10015710230 |

| Laminat (mm)       |             |
|--------------------|-------------|
| Traka: 2090 x 32   | 10004821150 |
| Traka: 4200 x 32   | 10004821155 |
| Ploča: 4200 x 1300 | 10011321150 |

## Zeleni mramor 4851 GL

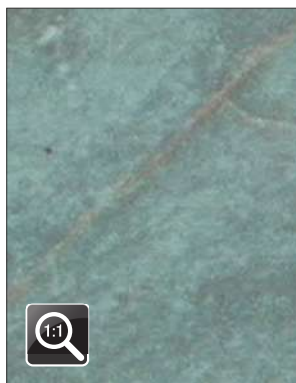

| Radna ploča (mm)   |             |
|--------------------|-------------|
| 28/R8 x 600 x 4200 | 10012505080 |

| Kutna letva / setovi kutnika |             |
|------------------------------|-------------|
| Trokutastog presjeka         | 10015800262 |
| tip 56                       | 10015710230 |

| Laminat (mm)       |             |
|--------------------|-------------|
| Traka: 2090 x 32   | 10004806920 |
| Ploča: 4200 x 1300 | 10011306025 |

## Larissa Verde 6078 GL

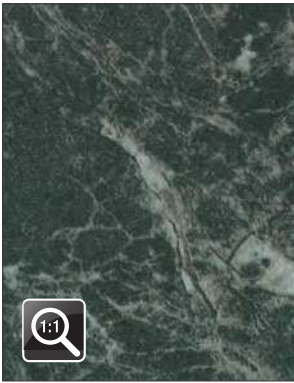

| Radna ploča (mm)   |             |
|--------------------|-------------|
| 28/R8 x 600 x 4200 | 10012502001 |

| Kutna letva / setovi kutnika |             |
|------------------------------|-------------|
| Trokutastog presjeka         | 10015800155 |
| tip 56                       | 10015710230 |

| Laminat (mm)       |             |
|--------------------|-------------|
| Traka: 2090 x 32   | 10004802101 |
| Ploča: 4200 x 1300 | 10011303301 |

## Larissa Verde 6078 TP



| Radna ploča (mm)   |             |
|--------------------|-------------|
| 28/R8 x 600 x 4200 | 10012502101 |

| Kutna letva / setovi kutnika |             |
|------------------------------|-------------|
| Trokutastog presjeka         | 10015800156 |
| tip 56                       | 10015710230 |

| Laminat (mm)       |             |
|--------------------|-------------|
| Traka: 2090 x 32   | 10004802201 |
| Ploča: 4200 x 1300 | 10011303411 |

## Mramor 0441 GL

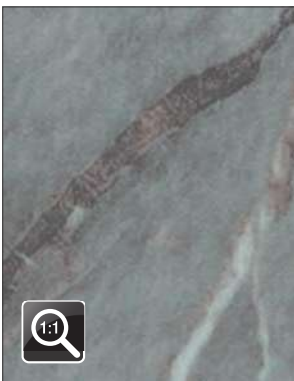

| Radna ploča (mm)   |             |
|--------------------|-------------|
| 28/R8 x 600 x 4200 | 10012560260 |

| Kutna letva / setovi kutnika |             |
|------------------------------|-------------|
| Trokutastog presjeka         | 10015801540 |
| tip 56                       | 10015710250 |

| Laminat (mm)       |             |
|--------------------|-------------|
| Traka: 2090 x 32   | 10004821160 |
| Traka: 4200 x 32   | 10004821165 |
| Ploča: 4200 x 1300 | 10011321160 |



## Bukva 44 CE



| Radna ploča (mm)   |             |
|--------------------|-------------|
| 28/R8 x 600 x 4200 | 10012500800 |
| Ploča stola (mm)   |             |
| 28/R8 x 800 x 4200 | 10001900300 |

| Kutna letva / setovi kutnika |             |
|------------------------------|-------------|
| Trokutastog presjeka         | 10015800085 |
| tip 56                       | 10015710240 |

| Laminat (mm)               |             |
|----------------------------|-------------|
| Traka: 2090 x 32           | 10004800800 |
| Ploča: 4200 x 1300         | 10011301900 |
| Rubna traka / narudžba: tm |             |
| Kod                        | 33040       |

## Trešnja 715 VE

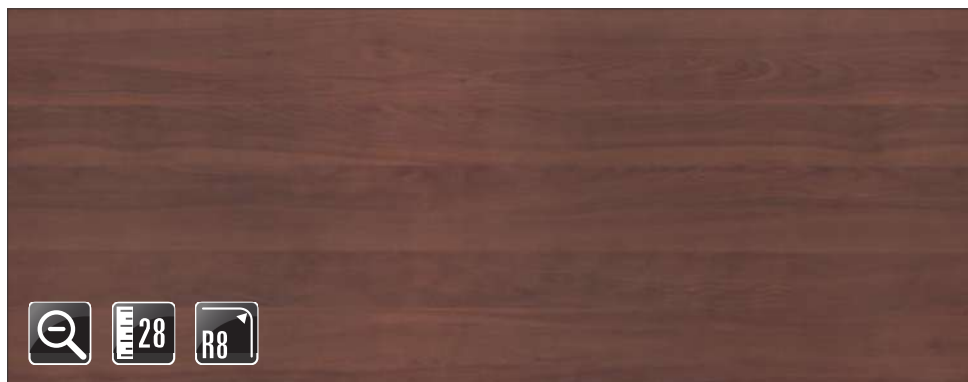
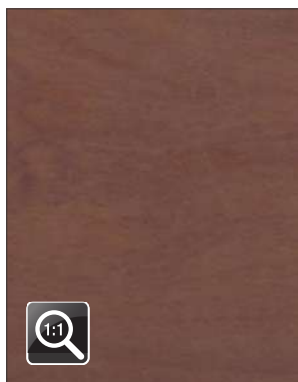

| Radna ploča (mm)   |             |
|--------------------|-------------|
| 28/R8 x 600 x 4200 | 10012500550 |
| Ploča stola (mm)   |             |
| 28/R8 x 800 x 4200 | 10001900160 |

| Kutna letva / setovi kutnika |             |
|------------------------------|-------------|
| Trokutastog presjeka         | 10015800060 |
| tip 56                       | 10015710270 |

| Laminat (mm)               |             |
|----------------------------|-------------|
| Traka: 2090 x 32           | 10004800560 |
| Ploča: 4200 x 1300         | 10011301320 |
| Rubna traka / narudžba: tm |             |
| Kod                        | 33470       |







## ■ Bianco 1048 Crystal

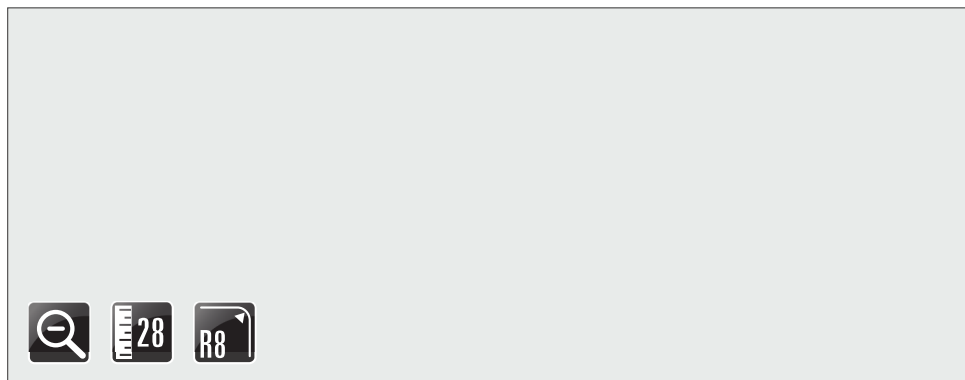
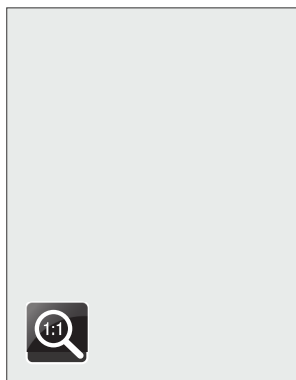

| Radna ploča (mm)   |             |
|--------------------|-------------|
| 28/R8 x 600 x 4200 | 10012506680 |

| Laminat (mm)     |             |
|------------------|-------------|
| Traka: 2090 x 32 | 10004807480 |

| Rubna traka / narudžba: tm |       |
|----------------------------|-------|
| Kod                        | 30030 |

## ■ Magnolia 3196 Bute

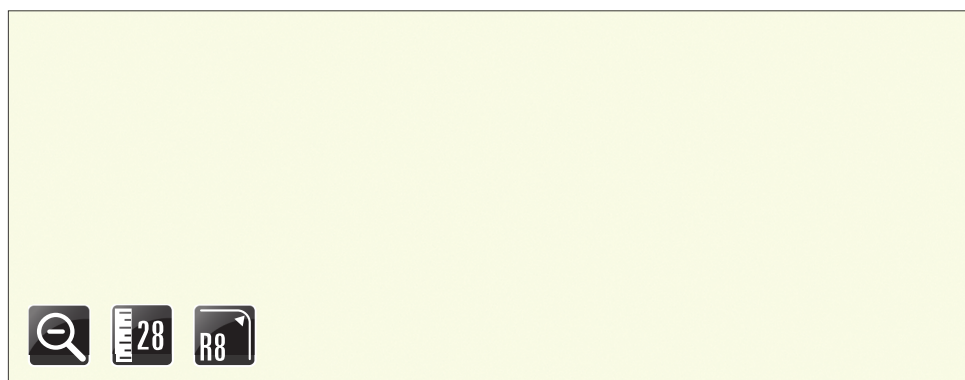
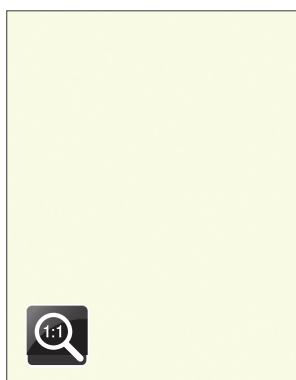

| Radna ploča (mm)   |             |
|--------------------|-------------|
| 28/R8 x 600 x 4200 | 10012506690 |

| Laminat (mm)     |             |
|------------------|-------------|
| Traka: 2090 x 32 | 10004807490 |

| Rubna traka / narudžba: tm |       |
|----------------------------|-------|
| Kod                        | 30301 |

## ■ Marmo Carrara 5410 Bute



| Radna ploča (mm)   |             |
|--------------------|-------------|
| 28/R8 x 600 x 4200 | 10012506710 |

| Laminat (mm)     |             |
|------------------|-------------|
| Traka: 2090 x 32 | 10004807510 |

**Chip Sand 5659 Bute**

| Radna ploča (mm)   |             |
|--------------------|-------------|
| 28/R8 x 600 x 4200 | 10012506720 |

| Laminat (mm)     |             |
|------------------|-------------|
| Traka: 2090 x 32 | 10004807520 |

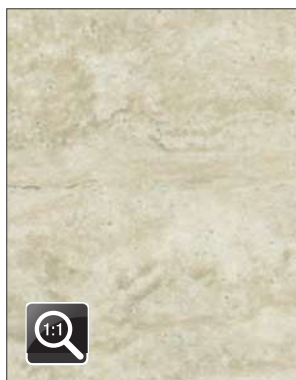
**Travertino 5052 Crystal**

| Radna ploča (mm)   |             |
|--------------------|-------------|
| 28/R8 x 600 x 4200 | 10012506700 |

| Laminat (mm)     |             |
|------------------|-------------|
| Traka: 2090 x 32 | 10004807500 |

**Rovere 4208 Oak**

| Radna ploča (mm)   |             |
|--------------------|-------------|
| 28/R8 x 600 x 4200 | 10012506740 |

| Laminat (mm)     |             |
|------------------|-------------|
| Traka: 2090 x 32 | 10004807540 |



## Noce Dark 4389 Dogal

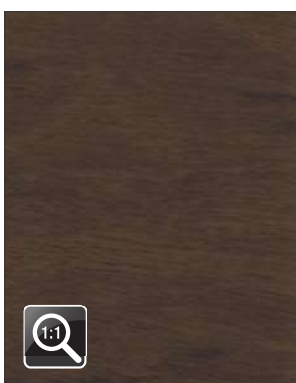

| Radna ploča (mm)   |             |
|--------------------|-------------|
| 28/R8 x 600 x 4200 | 10012506730 |

| Laminat (mm)     |             |
|------------------|-------------|
| Traka: 2090 x 32 | 10004807530 |

| Rubna traka / narudžba: tm |       |
|----------------------------|-------|
| Kod                        | 35460 |

## Wenghe 4572 Oak

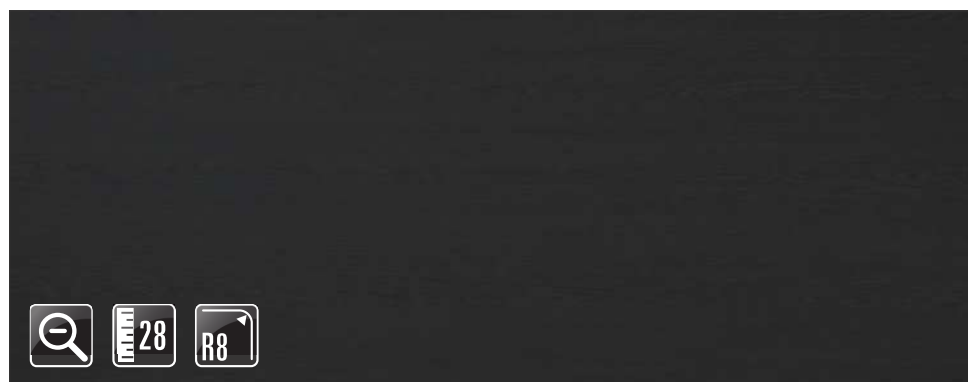
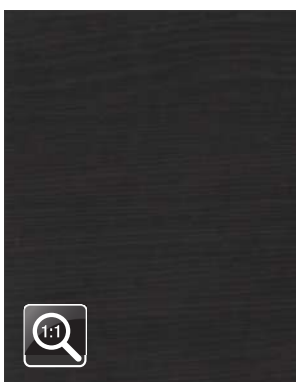

| Radna ploča (mm)   |             |
|--------------------|-------------|
| 28/R8 x 600 x 4200 | 10012506750 |

| Laminat (mm)     |             |
|------------------|-------------|
| Traka: 2090 x 32 | 10004807550 |

| Rubna traka / narudžba: tm |       |
|----------------------------|-------|
| Kod                        | 36173 |



EGGER F011





### Kolekcija uzoraka radnih ploča

Sadrži uzorke većine dekora radnih ploča u našoj ponudi u dimenzijama 60 x 100 mm

80300000004



### Ugradbena granitna ploča

- materijal: prirodni granit
- boja: crna, rosa betta, shivakashi, viscont white
- dimenzija: 300 x 20 x 400 mm
- zaobljenje kuta: R9 mm
- rub: 2 mm / 45°
- primjena: ugradnja u radnu ploču ili kao samostalni element (u slučaju oštećenja prilikom samostalne ugradnje ne snosimo nikakvu odgovornost)

Ugrađuje se u radnu ploču i namijenjena je za odlaganje vrućih posuda. Osim toga, može poslužiti i kao daska za rezanje.

Rubovi radne ploče na mjestu u kojem je upušteni granitni umetak su zaštićeni specijalnim ljeplom.

Granitna je ploča u odnosu na površinu radne ploče izdignuta 2 mm kako bi se HPL površina zaštitila i u slučajevima kada je veličina vruće posude veća od granitnog umetka.

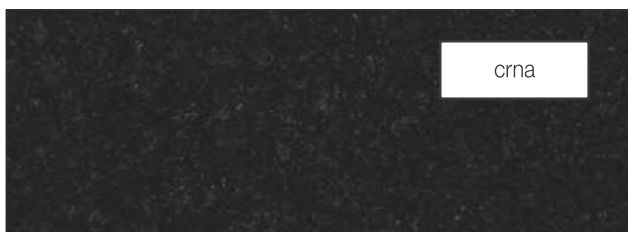

crna



shivakashi



rosa betta



viscont white

## Kutne letve, setovi kutnika



Kutne letve je potrebno pritisnuti uz zid i tako ih učvrstiti na radnu ploču. Osim toga, potrebno ih je i učvrstiti min. 5 cm od krajeva sa obje strane kako bi dobro prijanjale.

U setovima kutnika nalaze se završni elementi, u izvedbama desni (Dx) i lijevi (Sx) koji se tijekom ugradnje ne mogu zamijeniti



### Kutna letva tip 54

prazna, providna  
dužina: 4200 mm  
Uz kutne letve tipa 54 posebno se može naručiti laminatna traka širine  $32 \pm 2$  mm. Prilikom ugradnje laminatne trake u kutnu letvu moguća je potreba krojenja na mjeru ili učvršćivanja ljepljivom.

10015810000

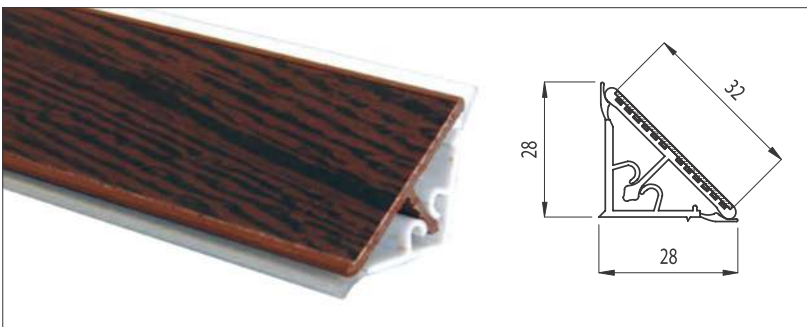

### Kutna letva tip 56

uljepljena, prozirna  
dužina: 4,2 m  
Uz radnu ploču je naveden broj artikla pripadajuće kutne letve.



### Kutna letva tip 65

aluminij rebrasta  
dužina: 4,0 m

10015710000

Preporučujemo set kutnika:  
svijetlo siva GA

10015710200



Dekori kutnih letvi se podudaraju sa dekorima sokla koje se nalaze na stranici:

**15.29**

### Kutna letva tip 66

materijal: plastika - aluminij  
dužina: 4,0 m

| boje             | broj artikla |
|------------------|--------------|
| sjajni aluminij  | 10015710020  |
| četkani aluminij | 10015710030  |
| mat aluminij     | 10015710040  |

## Kutne letve, setovi kutnika

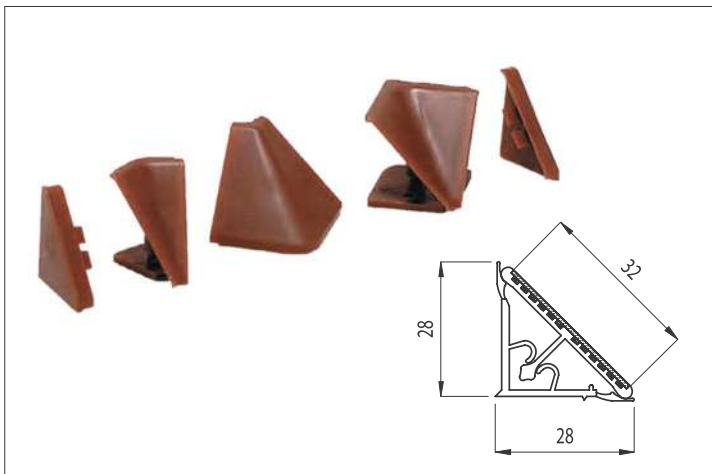

## Set kutnika tip 565

za kutne letve tipa 54, 56, 65 i 66

| boje              | broj artikla |
|-------------------|--------------|
| svijetlo siva GA  | 10015710200  |
| bijela BI         | 10015710210  |
| bež AV            | 10015710220  |
| siva GR           | 10015710230  |
| svijetlo smeđa RC | 10015710240  |
| tamno smeđa NO    | 10015710250  |
| crna NR           | 10015710260  |
| crvena CL         | 10015710270  |
| zeleni VR         | 10015710280  |

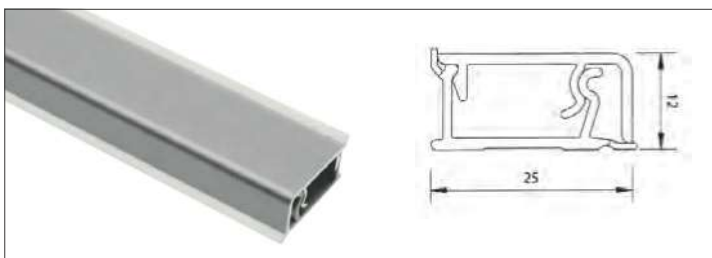

## Kutna letva tip 62

Aluminijska kutna letva, četrtastog presjeka, s kabel kanalom dužina: 4200 mm

| boje            | broj artikla |
|-----------------|--------------|
| mat aluminij    | 10015710010  |
| sjajni aluminij | 10015710011  |

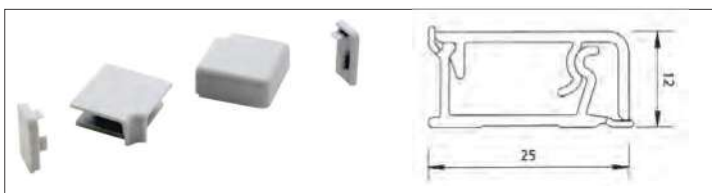

## Set kutnika tip 562

za kutnu letvu s kabel kanalom tip 62

boja: svijetlo siva

10015710190

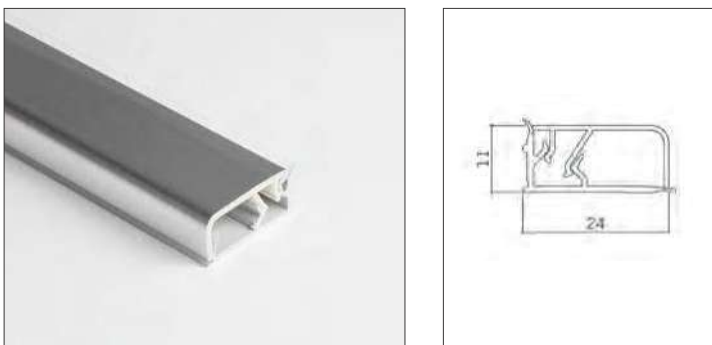

## Kutna letva tip 3505

materijal: plastika - aluminij

dužina: 4,0 m

| boje             | broj artikla |
|------------------|--------------|
| sjajni aluminij  | 10015710600  |
| četkani aluminij | 10015710610  |
| inox             | 10015710620  |

Zahvaljujući univerzalnom setu kutnika, kutna se letva može ugraditi polegnuto ili uspravno.

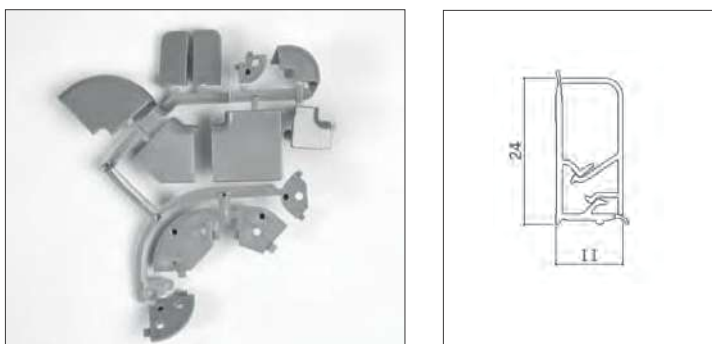

## Set kutnika tip 3505

za kutnu letvu tip 3505

| boje | broj artikla |
|------|--------------|
| siva | 10015710650  |
| inox | 10015710655  |



## Perfect Line kutna letva, setovi kutnika



Posebnost kutnih letvi Perfect Line je u tome što su manjeg trokutastog presjeka, niže su i puno se bolje stapaju sa površinom radne ploče tim više jer je prijelaz sa radne ploče na zid gotovo neprimjetan.

Ovaj dojam pojačava i tehničko rješenje skrivanjem gumene brtve.

| Kutna letva • dužina: 4,2 m |              | Završni elementi, kutnici |       |                       |                        |                   |                 |
|-----------------------------|--------------|---------------------------|-------|-----------------------|------------------------|-------------------|-----------------|
| boje                        | broj artikla | boje                      | tip   | desni završni element | lijevi završni element | unutarnji kut 90° | vanjski kut 90° |
| <b>Fantasy dekori</b>       |              |                           |       |                       |                        |                   |                 |
| Aluminij                    | 10015720000  | siva                      | 98102 | 10015729000           | 10015729050            | 10015729100       | 10015729150     |
| Inox                        | 10015720005  | siva-metal                | 98656 | 10015729001           | 10015729051            | 10015729101       | 10015729151     |
| <b>Kronospan dekori</b>     |              |                           |       |                       |                        |                   |                 |
| White Andromeda K217 GM     | 10015721210  | bijela                    | 91115 | 10015729002           | 10015729052            | 10015729102       | 10015729152     |
| Grey Andromeda K372 GM      | 10015721220  | siva-metal                | 98656 | 10015729001           | 10015729051            | 10015729101       | 10015729151     |
| Black Andromeda K218 GM     | 10015721230  | crna                      | 98104 | 10015729007           | 10015729057            | 10015729107       | 10015729157     |
| Light Lunar Stone K103      | 10015721170  | bež                       | 94129 | 10015729004           | 10015729054            | 10015729104       | 10015729154     |
| Dark Lunar Stone K104       | 10015721180  | siva                      | 98138 | 10015729008           | 10015729058            | 10015729108       | 10015729158     |
| Elegance Endgrain Oak K107  | 10015720055  | bež                       | 94129 | 10015729004           | 10015729054            | 10015729104       | 10015729154     |
| Raw Endgrain Oak K105       | 10015721190  | svijetlo smeđa            | 96138 | 10015729005           | 10015729055            | 10015729105       | 10015729155     |
| White Andromeda K217 GG     | 10015721130  | bijela                    | 91115 | 10015729002           | 10015729052            | 10015729102       | 10015729152     |
| Black Andromeda K218 GG     | 10015721135  | crna                      | 98104 | 10015729007           | 10015729057            | 10015729107       | 10015729157     |
| White Dunes K215            | 10015721120  | bijela                    | 91115 | 10015729002           | 10015729052            | 10015729102       | 10015729152     |
| Light Terrazzo Marble K095  | 10015721050  | siva                      | 98102 | 10015729000           | 10015729050            | 10015729100       | 10015729150     |
| Cloud Nebula K369           | 10015721240  | siva                      | 98138 | 10015729008           | 10015729058            | 10015729108       | 10015729158     |
| Bež Royal Marble K212       | 10015721090  | pijesak                   | 94126 | 10015729009           | 10015729059            | 10015729109       | 10015729159     |
| White Valley Granite K371   | 10015721250  | siva                      | 98102 | 10015729000           | 10015729050            | 10015729100       | 10015729150     |
| Crema Limestone K209        | 10015721080  | siva                      | 98102 | 10015729000           | 10015729050            | 10015729100       | 10015729150     |
| Grey Atlantic Marble K368   | 10015721260  | siva-metal                | 98656 | 10015729001           | 10015729051            | 10015729101       | 10015729151     |
| Grey Galaxy K207            | 10015721070  | siva-metal                | 98656 | 10015729001           | 10015729051            | 10015729101       | 10015729151     |
| Light Tivoli K214           | 10015721110  | bež                       | 94129 | 10015729004           | 10015729054            | 10015729104       | 10015729154     |
| Dark Tivoli K213            | 10015721100  | smeđa                     | 98149 | 10015729010           | 10015729060            | 10015729110       | 10015729160     |
| Light Atelier 4298          | 10015721150  | siva-metal                | 98656 | 10015729001           | 10015729051            | 10015729101       | 10015729151     |
| Dark Atelier 4299           | 10015721140  | smeđa                     | 98149 | 10015729010           | 10015729060            | 10015729110       | 10015729160     |
| Grey Craft Oak K002         | 10015721000  | siva                      | 98138 | 10015729008           | 10015729058            | 10015729108       | 10015729158     |
| Gold Craft Oak K003         | 10015721010  | drap                      | 94110 | 10015729006           | 10015729056            | 10015729106       | 10015729156     |
| Linen Block Wood K029       | 10015721020  | siva                      | 98138 | 10015729008           | 10015729058            | 10015729108       | 10015729158     |
| Light Porterhouse Oak K091  | 10015721030  | drap                      | 94110 | 10015729006           | 10015729056            | 10015729106       | 10015729156     |
| Dark Porterhouse Oak K092   | 10015721040  | svijetlo smeđa            | 96138 | 10015729005           | 10015729055            | 10015729105       | 10015729155     |

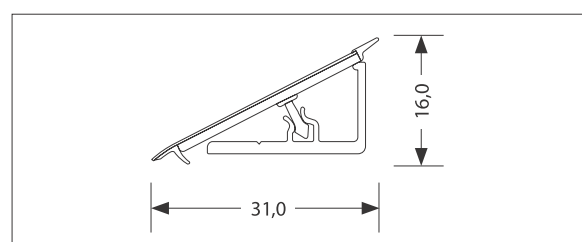

## Kutne letve, setovi kutnika



## Kutna letva tip 53

s kabel kanalom  
dužina: 4,0 m

| boje           | broj artikla |
|----------------|--------------|
| Marble 4828 QZ | 10015700600  |
| Bianco 2252 FC | 10015701100  |

Preporučeni set kutnika:  
bijela BI

10015701200



## Kutna letva tip 51

aluminij, s kabel kanalom  
dužina: 5,0 m

10015700100

Preporučeni set kutnika:  
siva GR

10015701400



## Set kutnika tip 526

za kutnu letvu tip 53 i 51 s kabel kanalom

| boje      | broj artikla |
|-----------|--------------|
| bijela BI | 10015701200  |
| siva GR   | 10015701400  |

## Spojni okov



## Spojni okov radnih ploča za debljinu 28 i 38 mm

površina: pocinčana  
narudžba: kom

| dimenzija (mm) | broj artikla |
|----------------|--------------|
| 65             | 10013302100  |
| 150            | 10013302000  |

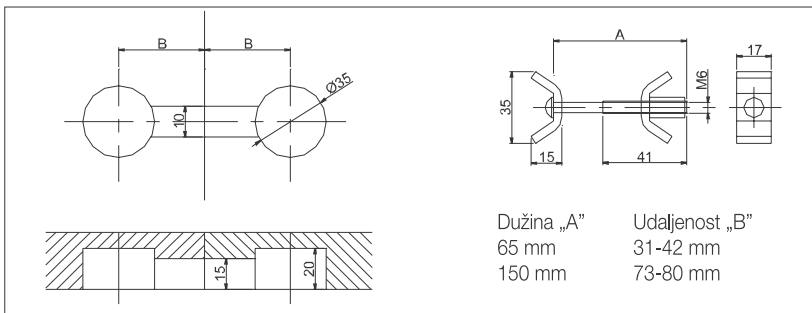

## Spojni okov radnih ploča

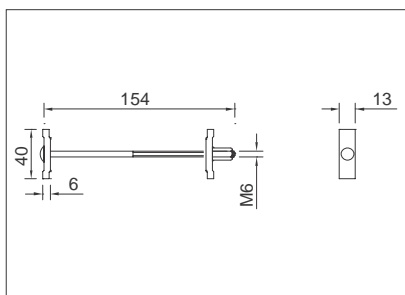

## Spojni okov radnih ploča za debljinu 16 mm

površina: pocinčana  
narudžba: par

10013303000

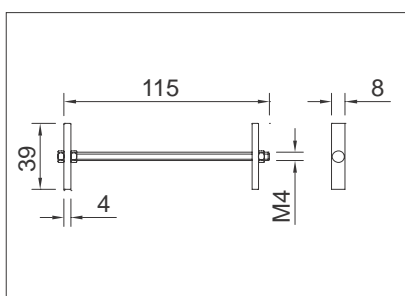

## Spojni okov kompakt ploča za debljinu 12 mm

površina: pocinčana  
narudžba: par

10013303010

## Okovi radnih ploča

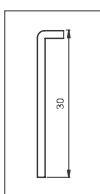

## Završni profil

Za radnu ploču debljine 28 mm

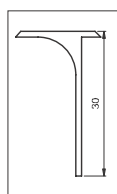

## Prijelazni profil

Za radnu ploču debljine 28 mm

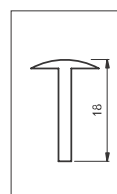

## Produžni profil

Za radnu ploču debljine 28 mm

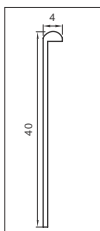

## Završni profil

Za radnu ploču debljine 38 mm

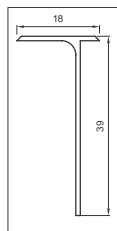

## Prijelazni profil

Za radnu ploču debljine 38 mm

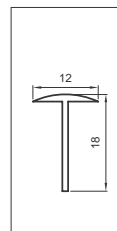

## Produžni profil

Za radnu ploču debljine 38 mm

| ★                 | boje                   | Za radnu ploču debljine 28 mm<br>R = 8 mm | broj artikla |             | Za radnu ploču debljine 38 mm<br>R = 3 mm |
|-------------------|------------------------|---|--------------|-------------|---|
|                   |                        |   | 50318        |             | 50315                                     |
| Završni profil    | natur - eloksirani     | 10013300100                               | 10013301600  | 10013301500 | 10013301700                               |
|                   | natur - elox. - 25 kom | 10013300101                               | -            | 10013301501 | -   |
|                   | bijela                 | 10013300300                               | -            | -           | -   |
|                   | crna                   | 10013300500                               | -            | -           | -   |
|                   | inox                   | -   | 10013301602  | -           | 10013301702                               |
|                   | patinirana             | -   | 10013301601  | -           | 10013301701                               |
| Prijelazni profil |                        | -   | 50319        | -           | 50316                                     |
|                   | natur - eloksirani     | 10013300200                               | 10013301610  | 10013301510 | 10013301710                               |
|                   | natur - elox. - 25 kom | 10013300201                               | -            | 10013301511 | -   |
|                   | bijela                 | 10013300400                               | -            | -           | -   |
|                   | crna                   | 10013300600                               | -            | -           | -   |
|                   | inox                   | -   | 10013301612  | -           | 10013301712                               |
| patinirana        | -                      | 10013301611                               | -            | 10013301711 |   |
| Produžni profil   |                        | -   | 50320        | -           | 50317                                     |
|                   | natur - eloksirani     | 10013301000                               | 10013301620  | 10013301520 | 10013301720                               |
|                   | natur - elox. - 25 kom | 10013301001                               | -            | 10013301521 | -   |
|                   | bijela                 | 10013301100                               | -            | -           | -   |
|                   | crna                   | 10013301200                               | -            | -           | -   |
|                   | inox                   | -   | 10013301622  | -           | 10013301722                               |
| patinirana        | -                      | 10013301621                               | -            | 10013301721 |   |

Produžni profil 56332  
R=9 mm

boje: natur - eloksirani

10013301630

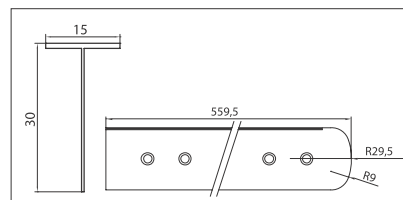



## Bar konzole



### Ravna konzola E5803

Pakiranje sadrži 1 konzolu i adapter s mogućnošću ugradnje drvenih polica. Dimenzija:  $\varnothing 50 \times 200$  mm

| boje      | broj artikla |
|-----------|--------------|
| krom      | 10006252210  |
| mat krom  | 10006252211  |
| mat nikal | 10006252212  |

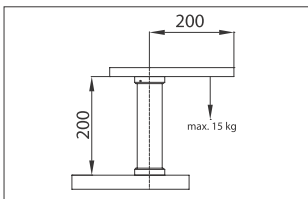

### Adapter za prihvat stakla

Za konzolu E5803  
10006252200



### Kosa konzola E5801

Pakiranje sadrži 1 konzolu i adapter s mogućnošću ugradnje drvenih polica. Dimenzija:  $\varnothing 50 \times 200$  mm

| boje       | broj artikla |
|------------|--------------|
| krom       | 10006252110  |
| mat krom   | 10006252111  |
| mat nikal  | 10006252112  |
| patinirana | 10006252113  |

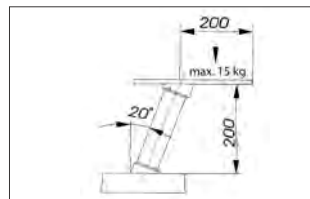

### Adapter za prihvat stakla

Za konzolu E5801  
10006252100

